

2024 MUSTANG SUPERCHARGER KIT GT / DARKHORSE

INSTALLATION INSTRUCTIONS

P/N: 422335

1324-LE6006P2



ROUSH[®]
P E R F O R M A N C E

28200 Plymouth Rd, Livonia, MI 48150 | 800.59.ROUSH

2024 Mustang Supercharger Kit GT / DarkHorse Installation Instructions

P/N: 422335

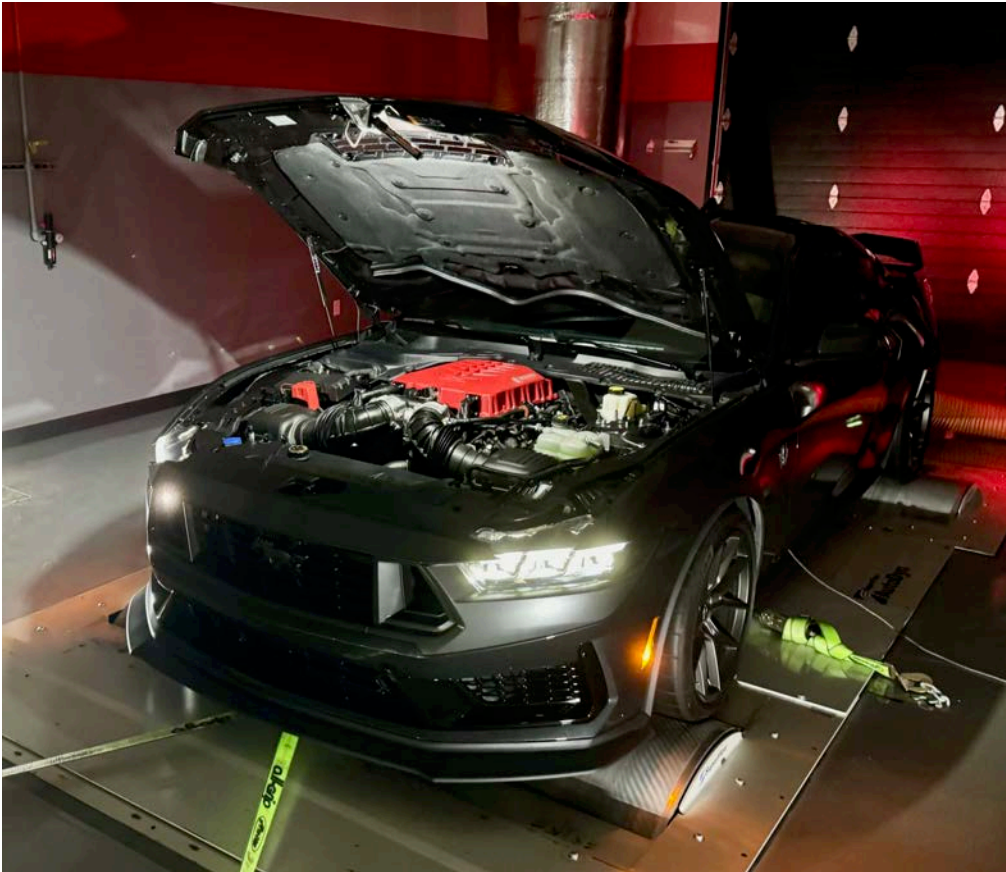

Application: 2024 Ford Mustang GT with 5.0L 4-Valve Engine

Important Notes:

- Before installing your Mustang ROUSHcharger Kit, please read the installation manual and verify that all items are present. If you are missing hardware or have any questions, please contact ROUSH Performance at 1-(800) 59-ROUSH.
- Premium fuel (91 octane or higher) is required to prevent “spark-knock” or detonation under certain operating conditions. **RATED POWER IS ON 93 OCTANE GASOLINE.**
- The use of fuel additives (i.e. octane boosters) is not recommended. There is a possibility that these chemicals can damage your engine and cause drivability issues with your vehicle.
- Operating your engine without the ROUSH PCM recalibration will result in engine damage or failure and will void your warranty.
- **5W50 SN PLUS OR SP FULL SYNTHETIC OIL IS REQUIRED** to be used. Change engine oil at time of supercharger kit installation
- **ATTENTION!** Your SUPERCHARGER kit is sensitive to corrosion! Use only the vehicle manufacturer recommended coolant for your engine in the intercooler system.

TABLE OF CONTENTS

INTRODUCTION.....	1
PACKING LIST.....	4
EQUIPMENT AND SUPPLIES REQUIRED.....	11
GLOSSARY OF TERMS.....	11
SUPERCHARGER BYPASS OPERATION.....	12
LIMIT OF LIABILITY STATEMENT.....	12
SAFETY PRECAUTIONS.....	12
SECTION A - DISASSEMBLY.....	13
SECTION B - INSTALLATION.....	25
SECTION C - MODULE PROGRAMMING.....	66
TEMPLATES.....	78

Note: To register your Roush supercharger kit, go to: <https://support.roushperformance.com/s/article/ROUSH-Performance-Warranty-Information>



PACKING LIST 2024 MUSTANG SUPERCHARGER KIT

BOX 1 - S/C ASSY			
REF #	PART	PN	QTY.
1	SUB ASSY, LID & INTERCOOLERS	NPN	1
2	BOLT - LID, HEX FLANGE M6x20mm	71-06-10-020	12
3	BOLT - LID, HEX FLANGE M6x55mm	71-06-10-055	6
4	PULLEY - 6K - 84mm	57-03-06-084-BL	1
5	BOLT, PULLEY, M6x16mm,	71-06-10-016	4
6	FUEL RAIL - RH	35-15-01-362-BL	1
7	FUEL RAIL - LH	35-15-01-363-BL	1
8	CROSSOVER, FUEL	31-10-00-110	1
9	FITTINGS, FUEL RAIL TO CROSSOVER	48-10-00-007	2
10	FITTING, FUEL INLET	69-12-41-002	2
11	O-RINGS	80-59-10-013	2
12	FITTINGS, FUEL RAIL CLOSEOUT	69-99-00-020	7
13	FITTINGS, FUEL RAIL CLOSEOUT	69-51-10-013	2
14	BOLTS, RAIL TO S/C m6x20mm	71-06-10-020	6
15	INJECTORS	84-12-41-050	8

Note: Sections that are highlighted grey color are a part of the supercharger sub-assembly.
DO NOT disassemble the supercharger sub-assembly. Part numbers are for reference only.



PACKING LIST 2024 MUSTANG SUPERCHARGER KIT

BOX 2 - FEAD			
REF #	PART	PN	QTY.
16	BRACKET - FEAD	65-26-50-003	1
17	IDLER, 6R, Ø60mm, FLAT,	56-06-01-060-BL	2
18	BOLT-HEX FLANGE M10-1.5X25mm	71-10-15-025	2
19	BOLTS - M8X1.25X60 SHCS	72-00-08-060	4
20	IDLER, 6R, Ø74mm, GROOVE	56-06-02-074	1
21	TENSIONER	56-50-53-050	1
22	BOLT - M8X60	71-08-12-060	1
23	BELT - K060710	K060710	1

HARDWARE KIT PN: 31-26-50-025

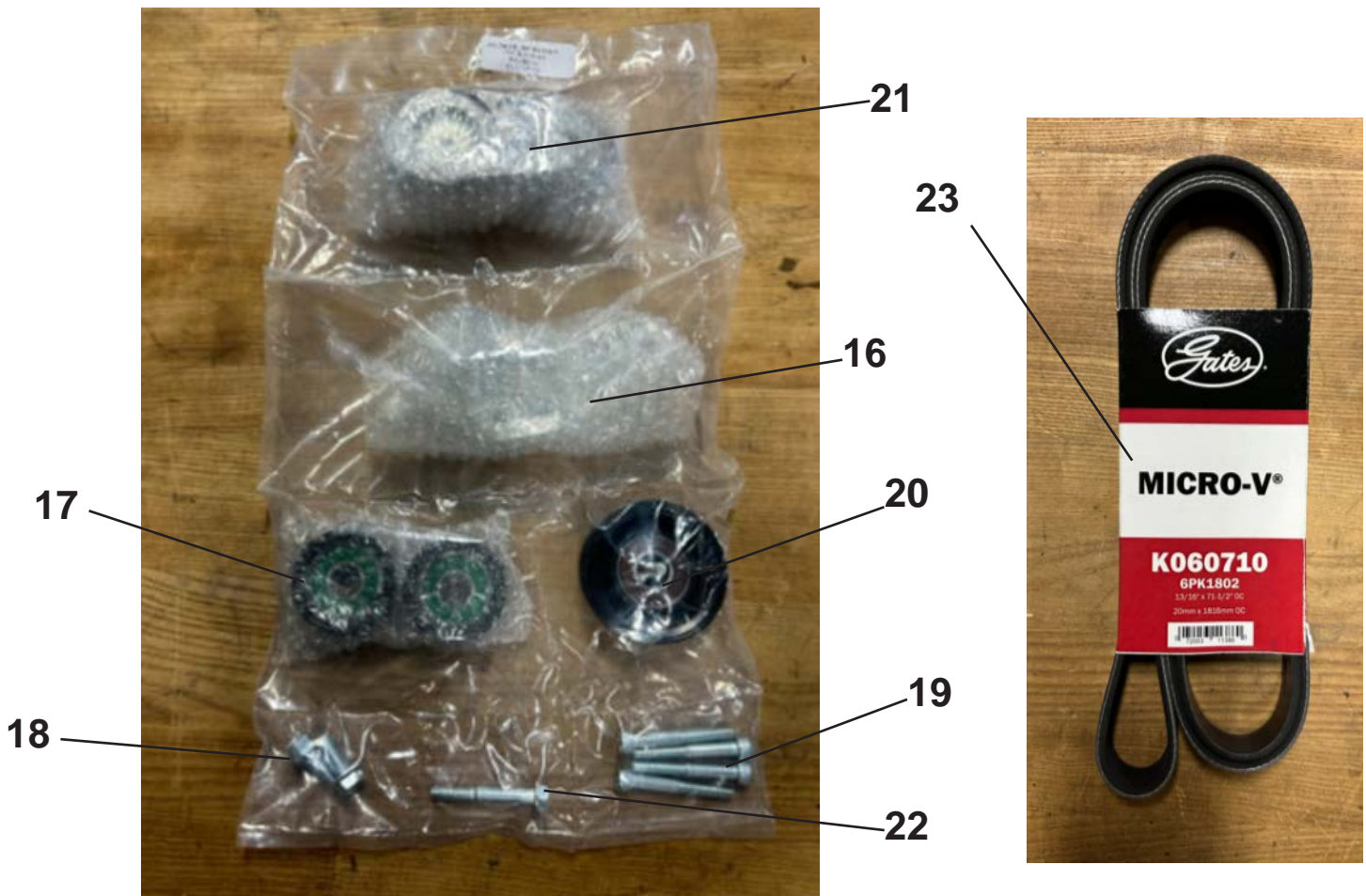

PACKING LIST 2024 MUSTANG SUPERCHARGER KIT

BOX 2 - INTERCOOLER			
REF #	PART	PN	QTY.
24	LOW TEMP RADIATOR	68-01-00-201	1
25	NUT, M8, LTR	77-08-12-001	2
26	WASHER, m8x16mm, LTR	75-00-08-016	2
27	DEGAS BOTTLE	68-01-03-024	1
28	RESERVOIR CAP	68-01-03-002	1
29	INTERCOOLER PUMP,	68-14-59-005	1
30	GROMMET, RUBBER	68-01-00-042	1
31	BRACKET - IC PUMP	65-26-50-007	1
32	HOSE KIT - COMPLETE	31-26-50-023	1
A	IC HOSE ASSEMBLY - CAC OUTLETS TO DEGAS INLET	31-26-62-023A	1
B	IC HOSE - DEGAS OUTLET TO PUMP INLET	31-26-62-023B	1
C	IC HOSE - PUMP OUTLET TO LTR INLET	31-26-62-023C	1
D	IC HOSE ASSEMBLY - LTR OUTLET TO CAC INLETS	31-26-62-023D	1
E	HEATER HOSE FEED - LH	31-26-62-023E	1
F	HEATER HOSE FEED - RH	31-26-62-023F	1
CT	CLAMP - CONSTANT TENSION (3/4" HOSE)	CT-3/4	8
SLV	ABRADABLE NYLON SLEEVE (24" LENGTH)	SLV-3/4	2
SW	SHRINK WRAP - HEAT SLEEVE ENDS (1.5" LENGTH)	SW-3/4	4
33	PCV HOSE LINE	31-26-50-029	1
34	HOSE, EVAP PURGE	82-55-00-002	1
35	CLAMPS, FOR 3/8" EVAP HOSE	48-46-05-001	2
36	SAE QUICK CONNECT, HEATER HOSE	48-46-02-077	1
37	P CLIP, 3/4" HEATER HOSE	48-46-10-022	2
38	CLIP, HOSE,	48-85-16-026	2
39	FITTING, HOSE MENDER	48-46-00-004	2
40	POWER GRIP	48-46-15-106	9
41	ZIP TIES - SMALL (7.5" LONG)	69-90-24-004	12

PACKING LIST 2024 MUSTANG SUPERCHARGER KIT

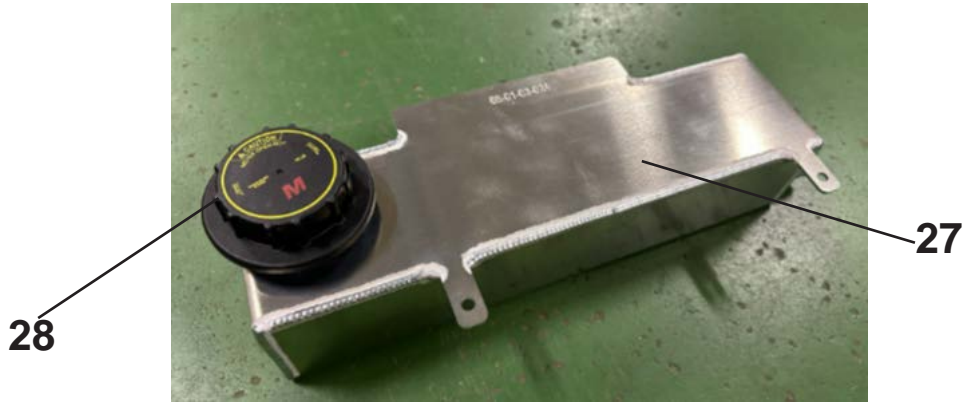

29



30



32



24

PACKING LIST 2024 MUSTANG SUPERCHARGER KIT

HARDWARE KIT PN: 31-26-50-027



PACKING LIST 2024 MUSTANG SUPERCHARGER KIT

BOX 2 - OTHER			
REF #	PART	PN	QTY.
42	SPARK PLUGS	88-99-00-024	1
43	BRACKET, VMV RELOCATION	65-26-50-015	1
44	BOLT-HEX FLANGE M6x30mm	71-06-10-030	7
45	BOLT-HEX FLANGE M6x75mm	71-06-10-075	3
46	CLAMP, CLEAN AIR TUBE PLUG	48-46-05-008	1
47	PLUG, CLEAN AIR TUBE	69-51-09-950	1
48	WIRING - IC PUMP	82-55-80-078	1
49	FUSE, 15AMP	82-55-50-115	1
50	WASHER, CRUSH, COPPER	75-65-10-016	1
51	BOLTS, M8x45mm	72-00-08-045	2
52	VOUCHER	P1324-P2-AA	1
53	RETAILDOC-AB	RETAILDOC-AB	1
54	TAPE FOAM 1/2" W X 1"T (LTR FRONT TO A/C)	90-72-00-004	30"
55	TAPE FOAM 0.75" X .187" T (LTR TOP BRACKET)	90-72-00-001	5"
56	TAPE FOAM 0.75"X .25" T (DEGAS REAR FLANG)	90-72-00-005	5"
57	NUT, IC HARNESS M6 HEX FLANGE	77-73-06-100	1
58	BOLT IC HARNESS M6 X 16	71-06-10-016	1



52

Use Voucher code for Section C - Module Programming.



53

Use RETAILDOC-AB for Warranty Registration.

PACKING LIST 2024 MUSTANG SUPERCHARGER KIT

HARDWARE KIT PN: 31-26-50-029



EQUIPMENT AND SUPPLIES REQUIRED

- 1/4" and 3/8" Drive Ratchets with Extensions
- Metric and Standard Socket Sets (short and deep recommended)
- Metric and Standard Wrench Sets
- 3/8" Drive Torque Wrench (7-35 ft-lb range)
- 6" Scale, Tape Measure, or Other Measuring Device
- Assembly Lubricant (White Lithium Grease or Petroleum Jelly)
- Electrical Tape
- Sharp Knife or Razor Blade
- Medium Strength Thread Locker – Loctite® 242 (blue) or equivalent
- Coolant (meeting Factory Ford specification for 2024 Mustang GT)
- 1/2" Drive Ratchet or Breaker Bar
- Short Phillips-head Screwdriver
- Heat Gun or Small Torch for Heat Shrink Tubing
- Trim Pad Tool (for pushpin removal)
- Fender Cover (2)
- 3/8" Drill Bit
- M8x1.25 Tap
- Heat Gun
- Dremel or small air grinder

GLOSSARY OF TERMS

Air Charge Temperature (ACT) Sensor (From the factory, this function is integrated into the MAF sensor. With this kit, a separate ACT sensor is installed into the intake manifold)

Electronic Throttle Control (ETC)

Mass Air Flow (MAF) Sensor

Manifold Absolute Sensor (MAP)

Powertrain Control Module (a.k.a. ECM, ECU, PCU, EEC)

Positive Crankcase Ventilation (PCV)

Supercharger Inlet Pressure (SIP)

Throttle Position Sensor (TPS)

ROUSH Diagnostic Tool (RDT)

Vapor Management Valve, or Evaporative Emissions Canister Purge Valve (EECPV)

Breakout Point – A place in an electrical harness where the wiring for an individual component leaves (breaks out of) the main harness to attach to an individual component.

INFORMATION ABOUT THE SUPERCHARGER BYPASS OPERATION

There is a great deal of misinformation about the function of the supercharger bypass systems. The supercharger is a positive-displacement pump; that is, so long as it is rotating, it is always pumping air. During low demand or high vacuum operation (i.e. idle, deceleration, and light throttle cruise), the pumping action is undesirable as it creates unwanted heat and noise. The bypass circuit, when open, prevents any pressure buildup across the supercharger and allows air to circulate through the rotors, allowing the supercharger to “idle” freely during these conditions. This results in reduced noise, and by reducing heat buildup in the intake, significantly improves street and strip performance. As throttle demand increases, the bypass circuit is closed, resulting in full performance from the supercharger. The bypass circuit is never used to limit or control boost during full-throttle operation and defeating or altering the bypass function will not result in improved performance in any condition, and will result in poor drivability.

LIMIT OF LIABILITY STATEMENT

The information contained in this publication was accurate and in effect at the time the publication was approved for printing and is subject to change without notice or liability. ROUSH Performance Products reserves the right to revise the information presented herein or to discontinue the production of parts described at any time.

SAFETY PRECAUTIONS



CAREFULLY READ THE IMPORTANT SAFETY PRECAUTIONS and WARNINGS BEFORE PROCEEDING WITH THE INSTALLATION! Appropriate disassembly, assembly methods and procedures are essential to ensure the personal safety of the individual performing the kit installation. Improper installation due to the failure to correctly follow these instructions could cause personal injury or death. Read each step of the installation manual carefully before starting the installation.

- Always wear safety glasses for eye protection.
- Place the ignition switch in the OFF position.
- Always apply the parking brake when working on the vehicle.
- Block the front and rear tire surfaces to prevent unexpected vehicle movement.
- Operate the engine only in well-ventilated areas to avoid exposure to carbon monoxide.
- Do not smoke or use flammable items near or around the fuel system.
- Use chemicals and cleaners only in well-ventilated areas.
- Batteries can produce explosive hydrogen gas which can cause personal injury. Do not allow flames, sparks or flammable sources to come near the battery.
- Keep hands and any other objects away from the radiator fan blades.
- Keep yourself and your clothing away from moving parts when the engine is running.
- Do not wear loose clothing or jewelry that can be caught in rotating or moving parts.

SECTION A – DISASSEMBLY

The following section will guide you through the disassembly of the stock components. Special care should be taken to label fasteners and parts that are taken off during this procedure since many will be reused:

1. Cover both fenders with fender covers to protect the vehicle finish.
2. Release the fuel system pressure.

NOTE: The following procedure is taken directly from the Ford Service Manual).

WARNING

Fuel in the fuel system remains under high pressure even when the engine is not running. Before working on or disconnecting any of the fuel lines or fuel system components, the fuel system pressure must be relieved. Failure to do so can result in personal injury.

WARNING

Do not smoke or carry lighted tobacco or open flame of any type when working on or near any fuel-related components. Highly flammable mixtures are always present and can be ignited, resulting in personal injury.

- a. Locate the under hood fuse panel.
- b. Remove the fuse for the fuel pump control module (Fuse F4 - 40 Amps Fuse) from the vehicle battery junction box (BCMC). Note: Refer to the fuse diagram shown below.
- c. Start the engine and allow it to idle until it stalls.
- d. After the engine stalls, crank the engine for approximately 10 seconds to make sure the fuel injector supply manifold pressure has been released.
- e. Turn the ignition switch to the OFF position.



3. Open the hood. Loosen the 3 retaining nuts on the battery cover located on the passenger side of the engine bay. Remove the battery cover.



4. Loosen and remove the ground terminal . (10 mm socket) Cover the ground post on the battery with a rag or tape. Repeat the process for the power terminal. (Torque: 44 lb.in (5 Nm))

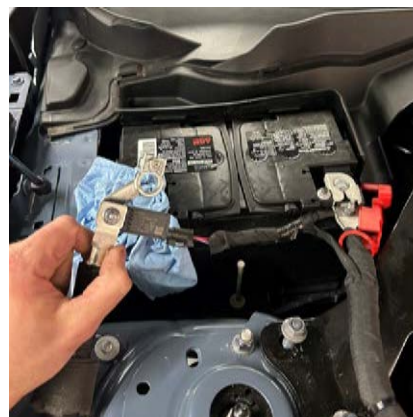

5. Remove the lower closeout panel shown. It has multiple push pins and screws retaining it. (7mm socket and a trim removal tool)



6. Connect a piece of hose to the radiator petcock. Turn the valve counterclockwise to open the drain valve and allow the coolant to drain. When it is done draining, tighten the valve and remove the drain hose. NOTE: Removing the coolant system cap will increase the flow.



7. Remove the strut tower brace. Locate the 4 mounting nuts. (15mm socket) Reinstall the takeoff bolts (Torque: 41 lb.ft (55 Nm)) . Note: The strut tower will not be reinstalled. Note: Non-Darkhorse or Non-Performance Pack 5.0 Mustangs may not be equipped with the strut tower.



8. Lift up on the engine cover to remove it. It will not be reinstalled.



9. Locate the quick connect fitting on the right-hand clean air tube. Squeeze the fittings and pull to remove it.



10. Remove the PCV fresh air tube from the left-hand clean air tube. Remove the line from the left-hand cam cover. Save the line, it will be reinstalled.



11. Remove the airbox lid from the left-hand clean air tube. There are 2 latches on the front side. Save airbox lid for re-use.



12. Remove the relay from the power distribution block, save relay for re-use. This can be done by releasing the clip with a flat blade screwdriver.



13. Remove the lid from the right-hand (passenger side) airbox. There are 2 latches on the front side.



14. Disconnect the MAF harness electrical connector. Use a trim tool to remove the zip tie fir tree from the clean air tube. Loosen the clamp on the throttle body. (7 mm socket) Repeat this step on the other side.

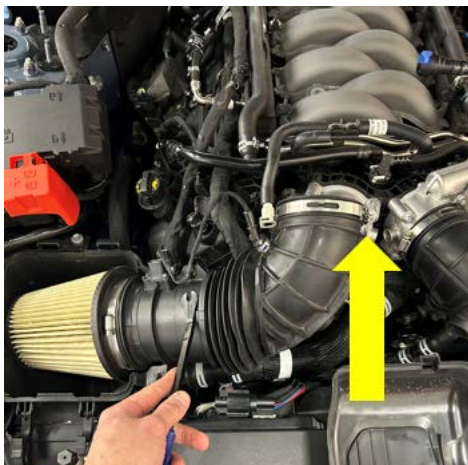

15. Remove the bolt holding the clean air tube to the airbox. (10mm socket.) Remove the clean air tube assembly. Repeat this step on the other side, save all parts for re-use.



16. Disconnect both throttle body electrical connectors. Remove the 8 throttle body bolts (8mm socket) and remove both throttle bodies. Remove the throttle body harness retainers from the intake manifold. Save all parts for re-use.

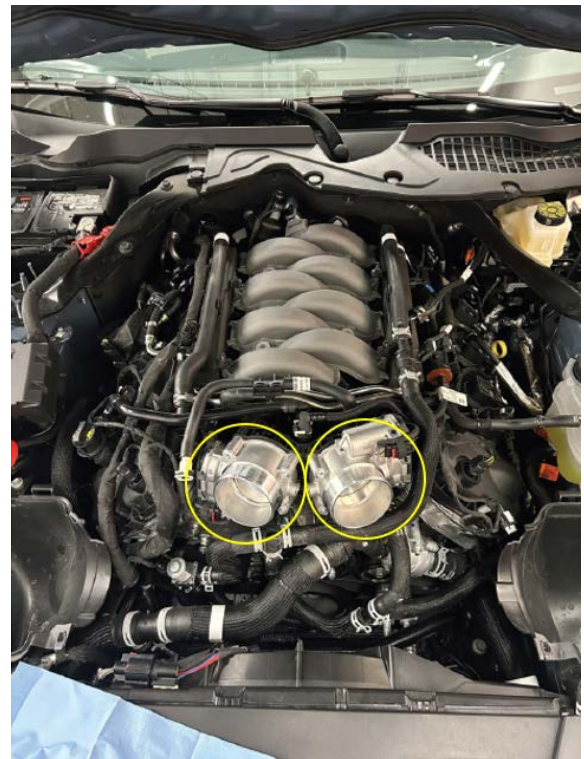

17. Disconnect the PCV hose from the intake manifold. Disconnect the other end from the right-hand cam cover and remove the hose. This hose will not be reused.



19. Release the quick connect fitting from the right-hand heater hose. Move the heater hose to the side of the engine compartment. It will be modified in another step.

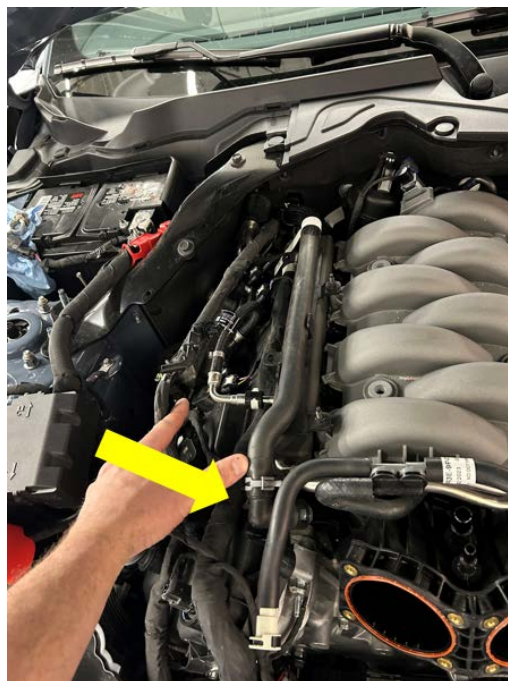

18. Remove the quick connect fittings that runs to the VMV valve. Disconnect the VMV electrical connections and the body side quick connect fitting. Save valve for re-use.



20. Disconnect the fuel rail supply and outlet line to the DI pump. Make sure to cover the fitting with rags and wear safety glasses and gloves to perform this step. **This step should only be attempted on a cold engine that has had the fuel pressure released already.**



21. Cap all lines that are open to keep debris from getting in. (2 fuel lines and 2 rail fittings)



22. Remove the 10 push clips on the radiator closeout panel using a trim removal tool, remove the radiator closeout panel and save for re-use.

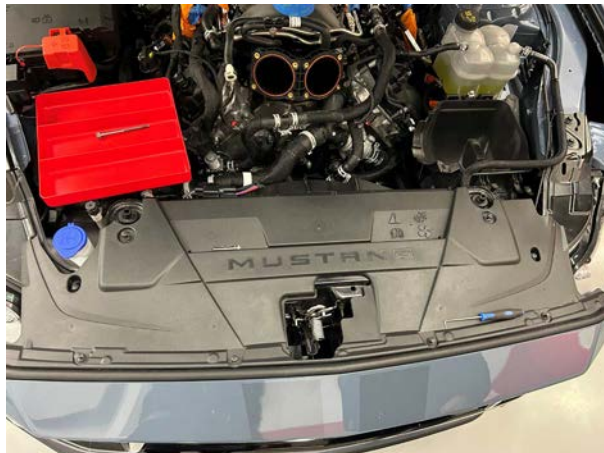

23. Remove the bolt holding the lower left hand (driver side) airbox tray. Remove the lower airbox tray. It will be reinstalled at a later step. (10mm socket)



24. Remove the bolt holding the lower right hand (passenger side) airbox tray. Remove the lower airbox tray. It will be reinstalled at a later step. (10 mm socket)



25. Remove the retainer clip from the left-hand side heater hose.



26. Disconnect the quick connector fitting on the left-hand heater hose. Move the hose towards the outside of the engine bay.

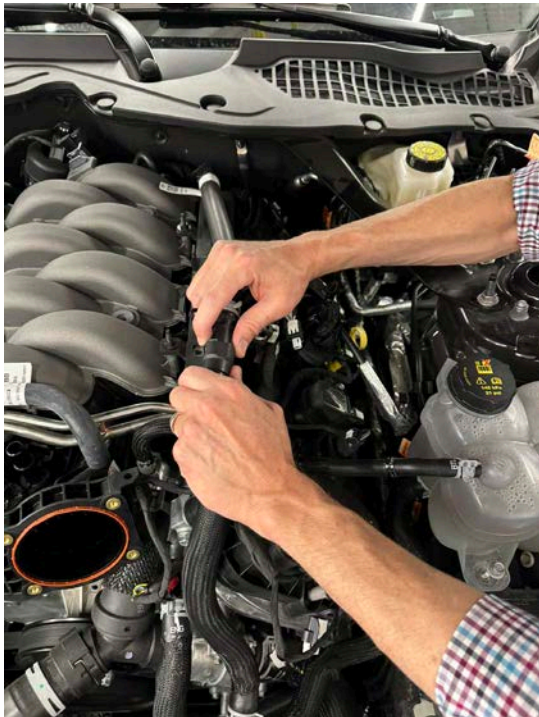

27. Remove the 4 bolts holding the heater hose trays to the intake manifold. Remove the injectors insulators. They will not be reused. (10mm socket)

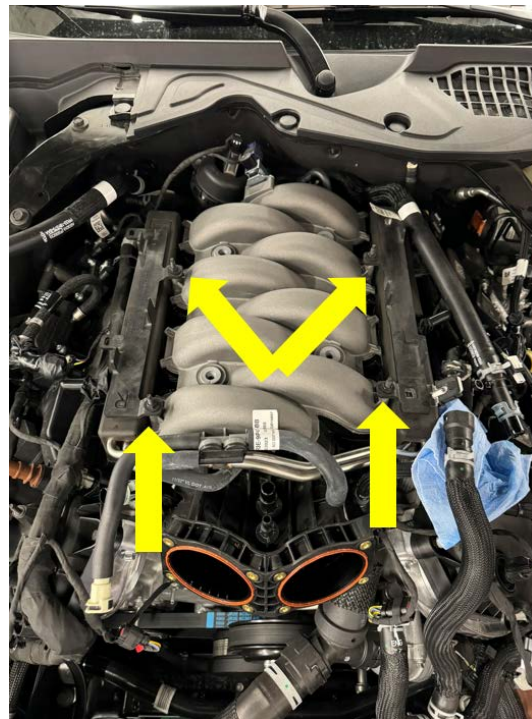

28. Disconnect the 8-port fuel injector electrical connectors and the fuel rail pressure sensor connector.

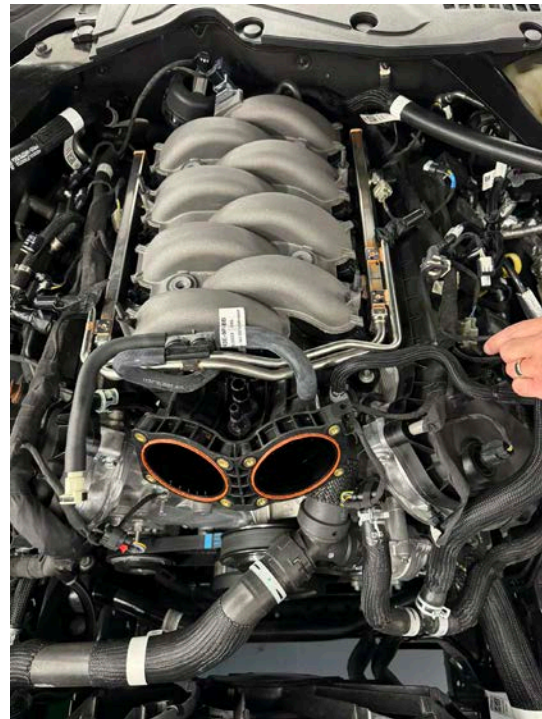

29. Remove the retainers holding the wiring harness to the cam covers.

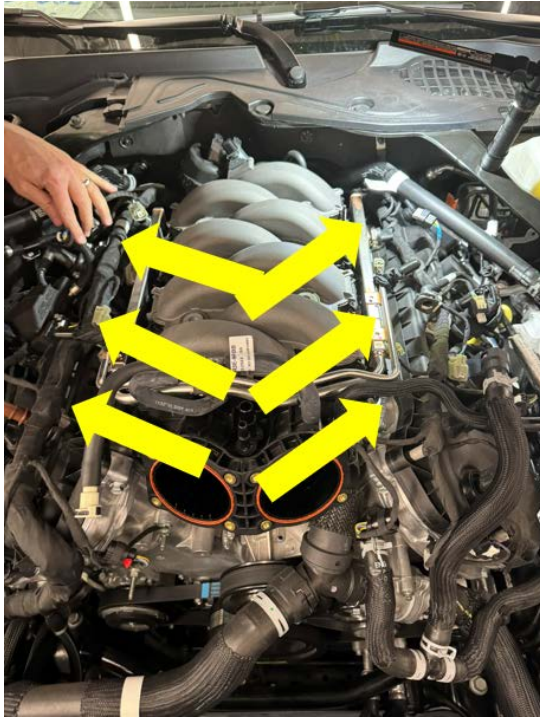

30. Remove the 4 fuel rail bolts, then remove the 6 intake to the cylinder head bolts. (10mm, 8mm socket)



31. Lift the intake and move it forward to gain access to the plugs on the back. You need to disconnect the two IMRC connectors, the map sensor connector and the vacuum solenoid connector. NOTE: There are two fir tree connectors retaining the cross over wiring harness to the intake. The DI fuel rail harness is secured on the lower driver's side of the manifold. Once all of the above electrical connectors are disconnected, carefully remove the intake manifold from the vehicle, save part for re-use.

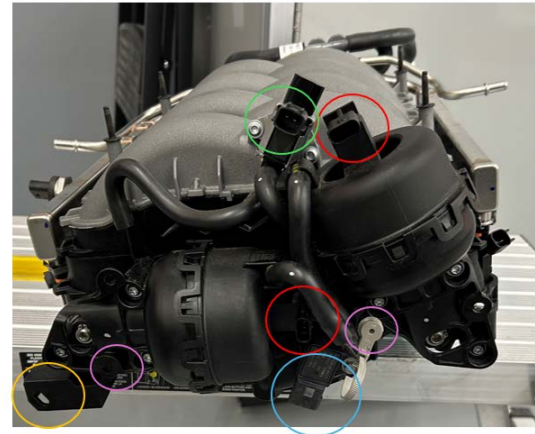

32. Vacuum the intake ports and verify nothing fell into any of the intake runners. Clean the mounting surface with brake cleaner and tape over the ports.

Note: Powertrain warranty will be voided if anything falls into the intake runners, this will cause catastrophic engine failure.



33. Remove the two foam blocks in the valley of the engine. They will not be reused.



35. Cut the AC belt to remove it. It will be discarded.
(Knife or large scissors)

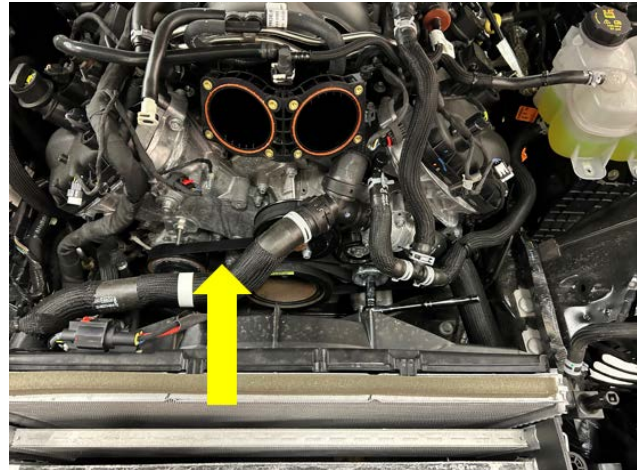

34. Loosen water pump bolts using a 10mm socket
(DO NOT REMOVE BOLTS!) then remove the water pump / alternator belt. Turn the tensioner pulley counterclockwise using a 15mm socket. Save the belt, it will be reinstalled in a later step.

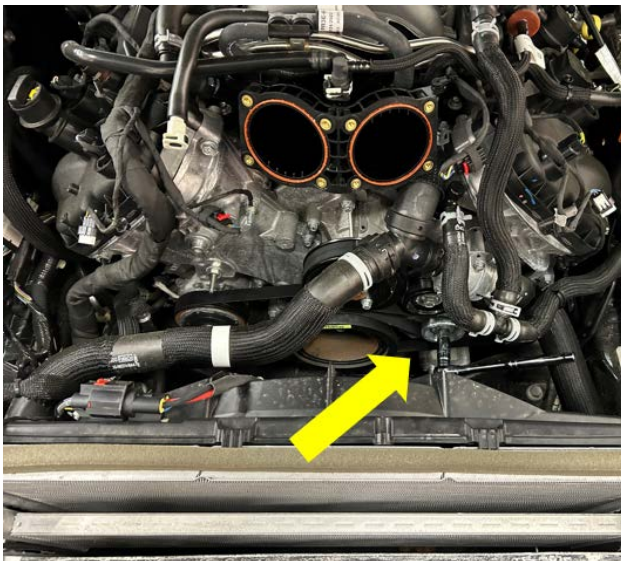

36. Remove the water pump pulley bolts and pulley.
They will be reused. (10mm socket)

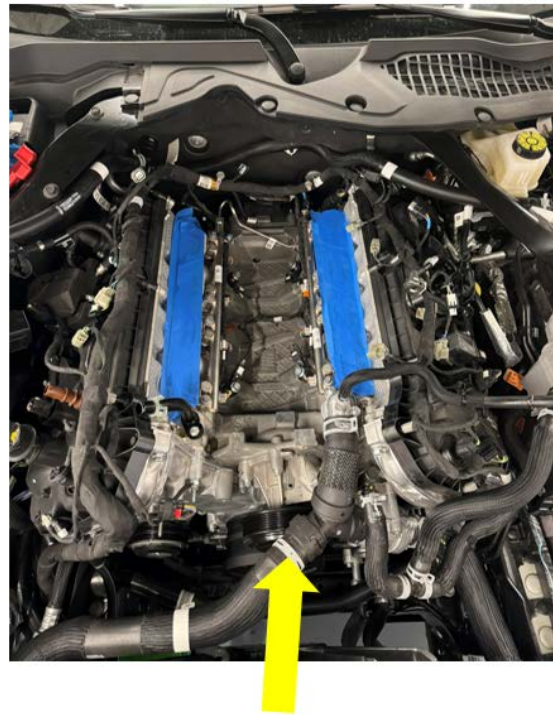

37. Remove the bolt from the front cover (yellow arrow). It will be discarded. Remove the ground stud (red arrow) and relocate it to the yellow arrow location. (10mm, 13mm sockets)



38. Previous step completed with the ground stud moved to new position as shown.



39. Remove the 4 bolts securing the 2 radiator mounts, keep for later reinstallation. (10 mm socket)



40. Remove the stud in the location shown. It will not be re used.

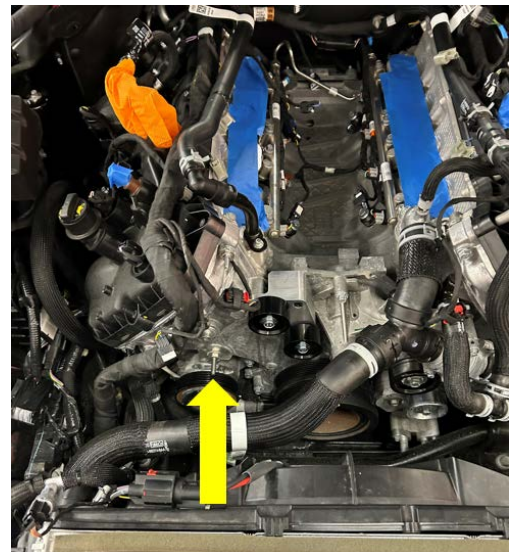

41. For Auto cars only: Remove the transmission fluid heater coolant control valve bracket. This is located on the right-hand side front cover. Keep bracket and hardware for reinstall.

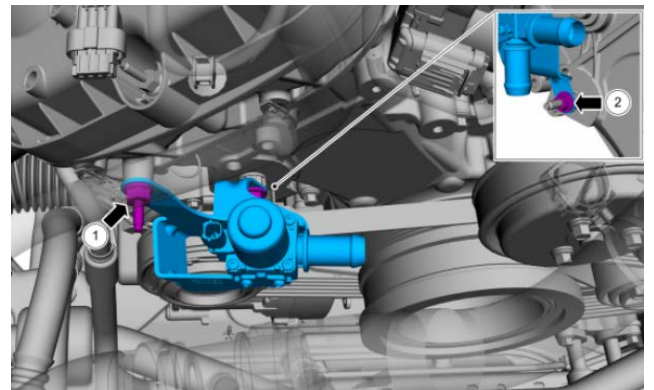

42. Remove the 2 bolts from the water pump at the location show, they will not be reused.



43. Locate and test fit the FEAD bracket (Item# 16, page 5) by holding it up to the front cover to determine cut length shown. The cut must be below the flat surface of the idler bracket mount as shown below.

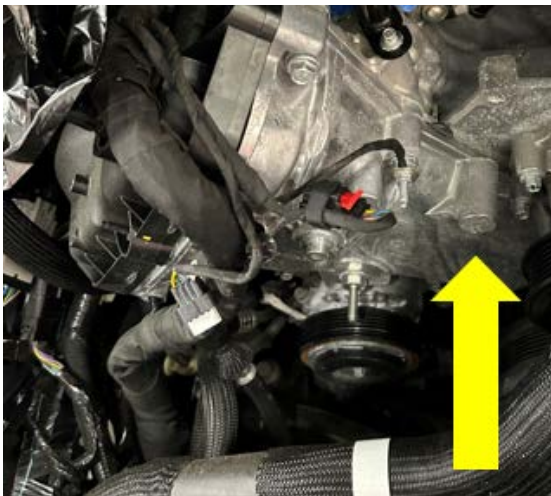

44. Verify the cut from the previous step, it needs to be equal or slightly below the idler bracket when installed. Clean up the debris but keep the engine covered.

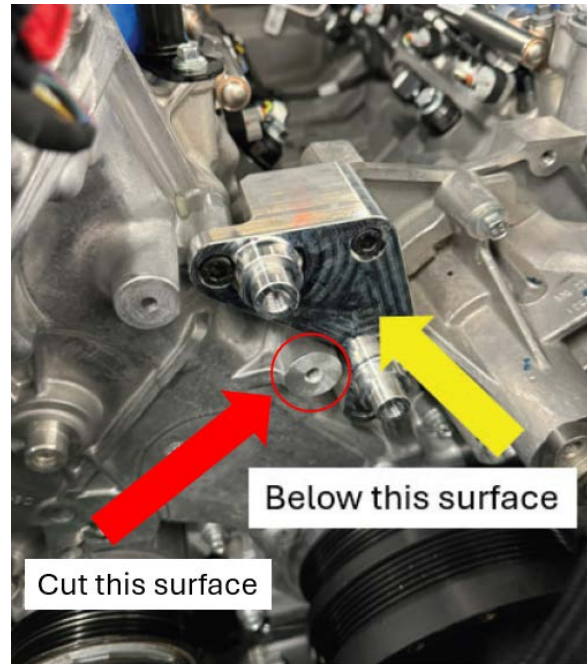

45. For Performance Pack ONLY: Cut the following metal tabs off the "K" brace. This is on the left side of the cowl area.



46. For Auto cars only: Locate the transmission fluid heater coolant control valve bracket from page 21 step 41. Modify the bracket as shown. Remove the valve from the bracket and cut the mount shown. Note: The lower leg will be removed from the valve mount. Spray black paint on cut area to prevent corrosion. Save part for re-use.



Continue To Section B: Installation

SECTION B – INSTALLATION

The following section will guide you through the installation of the supercharger kit into the vehicle.

If you need to stop during any part of the installation, make sure you cover any open ports in the cylinder heads or intake manifold to prevent foreign material from contaminating the engine.

1. For Auto cars only: Reinstall the transmission fluid heater coolant control valve bracket (Disassembly section, page 23 step 46) onto the post as shown.



2. Locate the 4 socket head cap bolts M8x60mm (Item 19, page 5). Install the idler bracket (Item 16, page 5) onto the engine. Torque all bolts to 25 Nm. (H6 socket)
Note: 2 bolts through water pump, 1 bolt through cylinder block, and 1 bolt through front cover into the cylinder head.

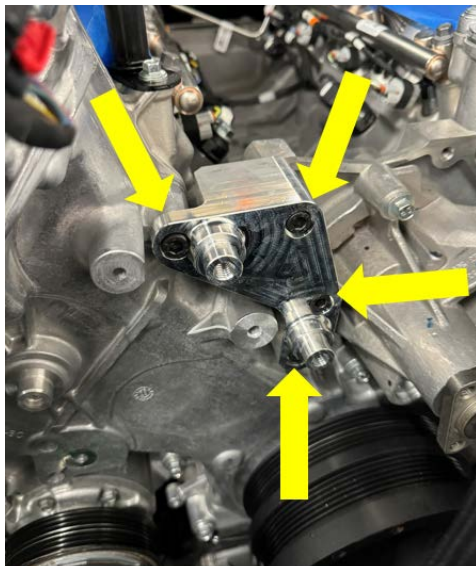

3. Install 2 idlers (Item 17, page 5) from hardware kit 31-26-50-025 on the idler post shown using 2 M10x25mm bolts (Item 18, page 5) from the same hardware kit. Torque bolts to 55Nm. (14mm socket)

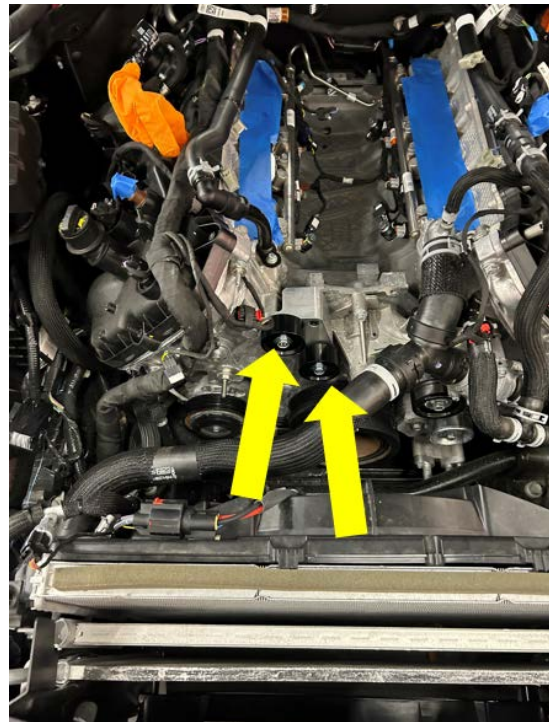

4. Install the provided tensioner (Item 21, page 5) from hardware kit 31-26-50-025 in the location shown and orientation shown. Use the provided m8x60mm bolt (Item 22, page 5) from the same hardware kit. Torque the bolts to 25 Nm. (12mm socket)

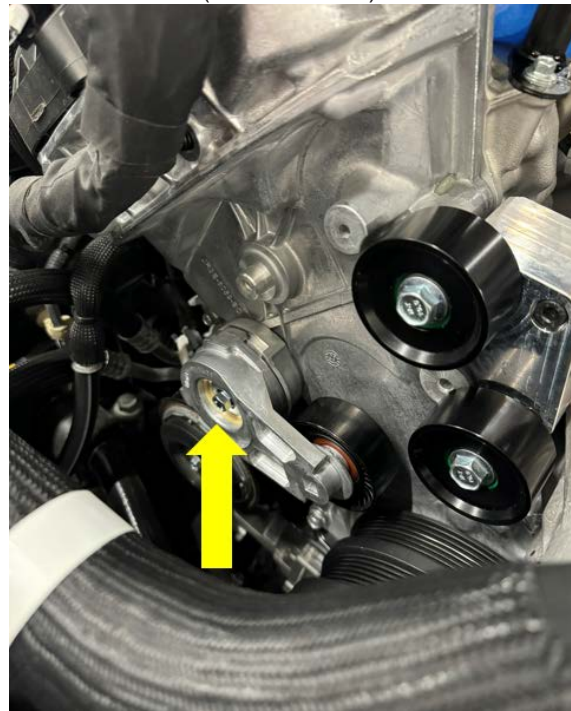

5. Install the ribbed idler pulley assembly (pulley and bolt) (Item 20, page 5) from hardware kit 31-26-50-025 into the location shown. Torque the bolt to 25Nm. (10mm socket)



6. Install the new belt K060710 (Item 23, page 5) as shown. **Note: Since the supercharger is not installed yet, we recommend routing the lower section correctly and leaving the bulk of the belt at the upper idler pulleys. Reference to belt diagrams on the last page of this manual.**

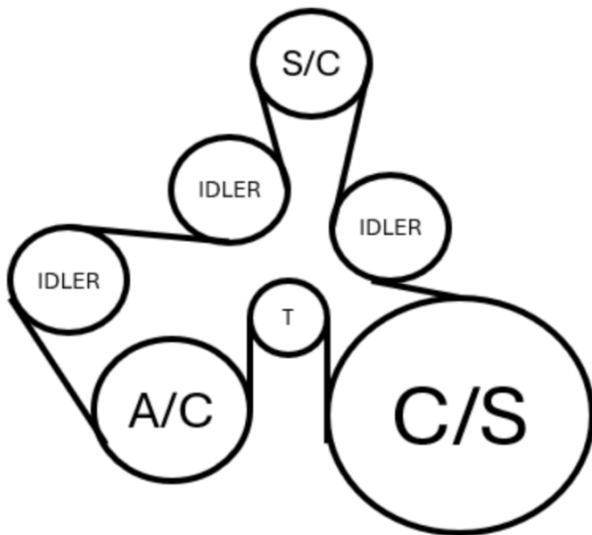

7. Reinstall the water pump pulley and bolts. Torque to 25 Nm.



8. Reinstall the factory water pump/ alternator belt (FEAD belt) as shown. (15mm socket) **Note: reference to belt diagrams on the last page of this manual.**

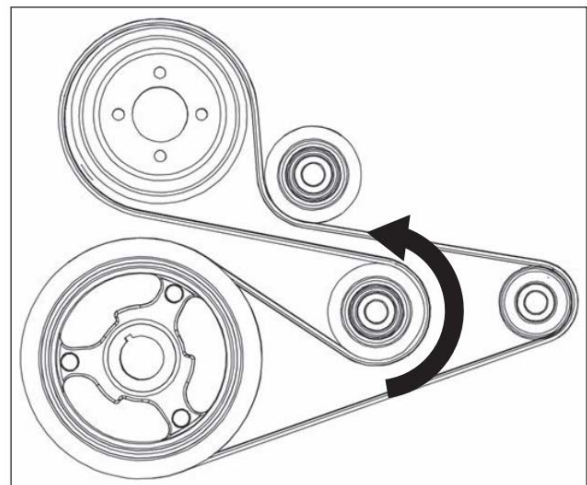

9. Remove the following 2 DI fuel rail bolts. They will not be reused. (10 mm socket)

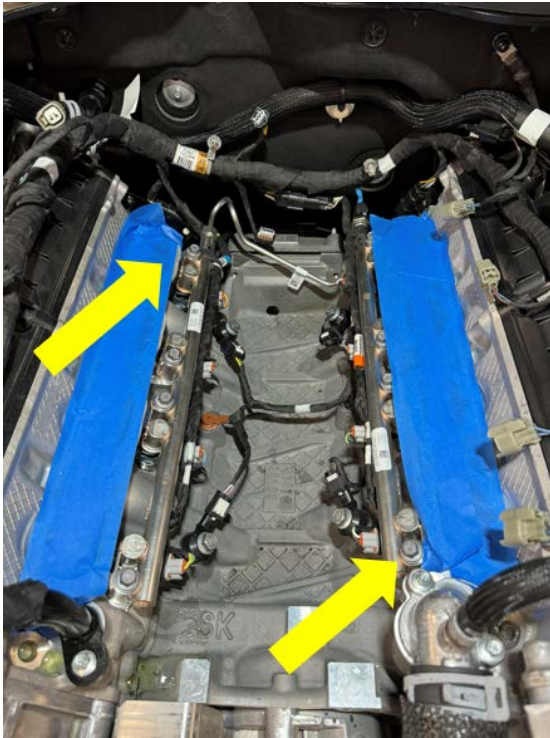

10. Gather the 2 provided socket head cap bolts M8x45mm (Item 51, page 10) from hardware kit 31-26-50-029. Install the bolts into the location from the previous step. Torque to 25Nm. (H6 socket)



11. Disconnect the electrical connectors for each ignition coil. (7 cylinders, **skip cylinder 3**) Remove the 7 coil mount bolts, keep all hardware for re-use. (8mm socket)

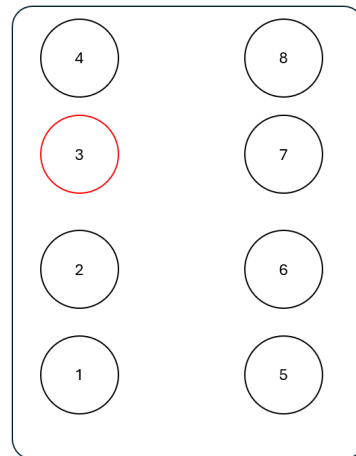

FRONT OF VEHICLE

12. Remove the 7 coil on plug assemblies and label them one at a time so they can be reinstalled in their original positions. Remove the spark plug boot from the cylinder 3 location. Note: A slight twisting motion will break the seal and ease removal.



13. Use a 5/8" spark plug socket and 6" extension to remove the 8 factory spark plugs and set them aside. The factory spark plugs will not be re-used.



14. Locate the new 8 spark plugs (Item 42, page 10) from hardware kit 31-26-50-029. Verify the gap is between 0.028-0.031" (0.7-0.8 mm). Check to ensure the gap is intact and none are damaged.



15. Install the supplied spark plugs into all 8 cylinder locations. Torque them to 15 Nm. Reinstall the 7 coils back into the 6 cylinder locations and spark plug boot into the cylinder #3 location. Torque the coil bolts to 10 Nm. Reconnect the electrical connectors to the 8 coils. (5/8 spark plug socket, 8mm socket)



16. Modify the engine degas hose located on the left side (driver side) of the engine as shown. Remove 3/4" inch of hose from the bleeder hose as shown. The cut should be close to the bottom of the word ENG. Reinstall the hose onto the barb and reuse the factory constant tension clamp.

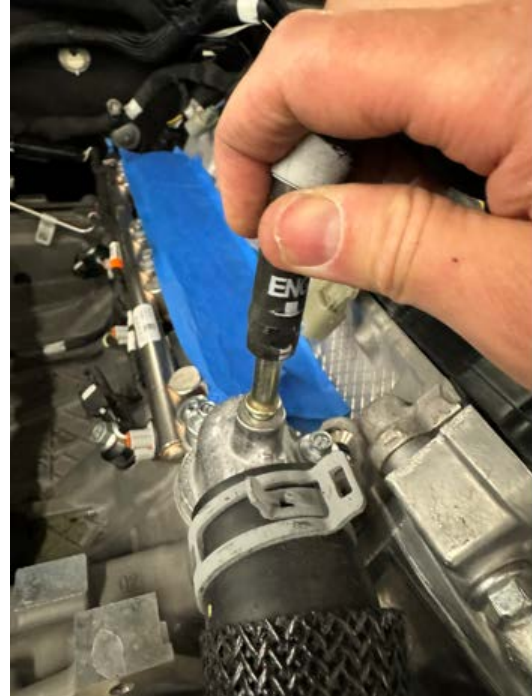

17. On the back side of the engine, remove the harness retention clip from the electrical harness. They will not be reused. (3 locations)



19. Remove the stud shown on the back of the left-hand side (driver side) cylinder head. **Replace the bolt with one of the takeoff MAF to airbox mounting bolts.** (13mm open end wrench, 10mm socket)



18. Tape the IMRC connector and connectors up and to the harness. **The only connector needed on the engine harness in this locations is the MAP sensor connector.**



Takeoff
bolt from
cylinder
head MAF to airbox
 mounting bolt



20. Follow the previous step, this is what it should look like with the new bolt installed.



21. Locate the hose 31-26-50-023E from hose kit 31-26-50-023. This hose will be used later to connect the OEM heater hoses.



22. **For Manual cars only:** Modify the hose from the last step as shown. Cut 4 inches of hose from the end, keep it for install in a later step. Discard the rest of the hose.



23. Located on the left side (driver side) of the engine bay, Release the constant tension clamp and remove the male quick connect fitting off the OEM heater hose. Save part for re-use.

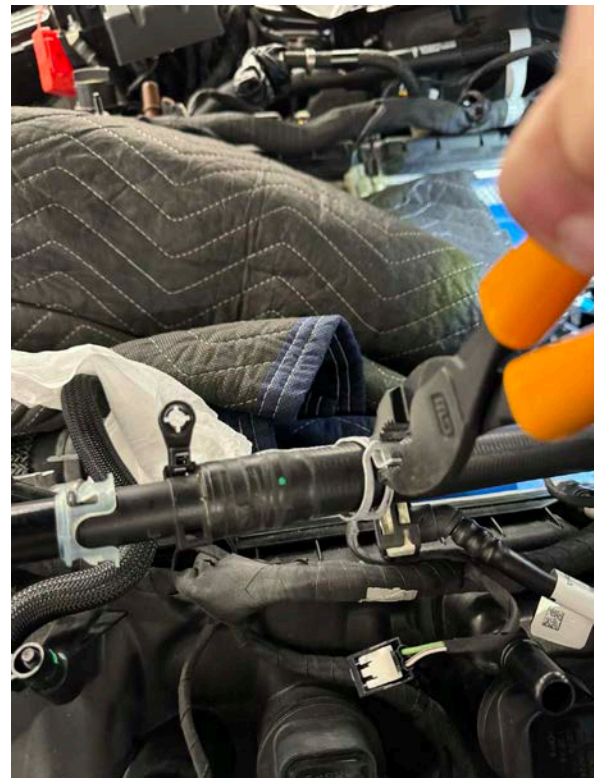

24. Install the supplied hose sleeving (Item SLV, page 6) from hose kit 31-26-50-023 over the OEM heater hose on the left side (driver side) and secure the hose sleeving by installing shrink wrap (Item SW, page 6) from the same hardware kit on each end of the hose sleeving, use a heat gun to apply heat to the shrink wraps evenly until it has shrunk around the hose and is shiny. **Make sure the hose sleeving is protecting the hose around the rear of the cylinder head.**



For Manual cars: Follow steps 26-27 for heater hose modifications.

For Automatic cars: Follow step 28-29 for heater hose modifications.

CONTINUE TO THE NEXT PAGE.

25. Route the heater hose along the back of the cylinder head and behind the ground strap as shown.



26. For Manual cars only: Install the provided $\frac{3}{4}$ " hose mender (page 8, Item 39) and power grip clamp (page 8, Item 40) from hardware kit 31-26-50-027 at the end of the OEM heater hose on the left side (driver side) as shown. Using a heat gun to apply heat to the clamp evenly until it has shrunk around the hose and is shiny.



27. For Manual cars only: Take the 4" piece cut from step 22 and install it onto the hose mender with a power grip clamp securing it. Using a heat gun to apply heat to the clamp evenly until it has shrunk around the hose and is shiny.



28. For Automatic cars: Located on the front side engine bay, release the constant tension clamps to remove the OEM heater hose off the vehicle as shown. Save clamps for re-use, Discard the hose.

Note: The heater hose along the left side (driver side) of the engine bay will stay.

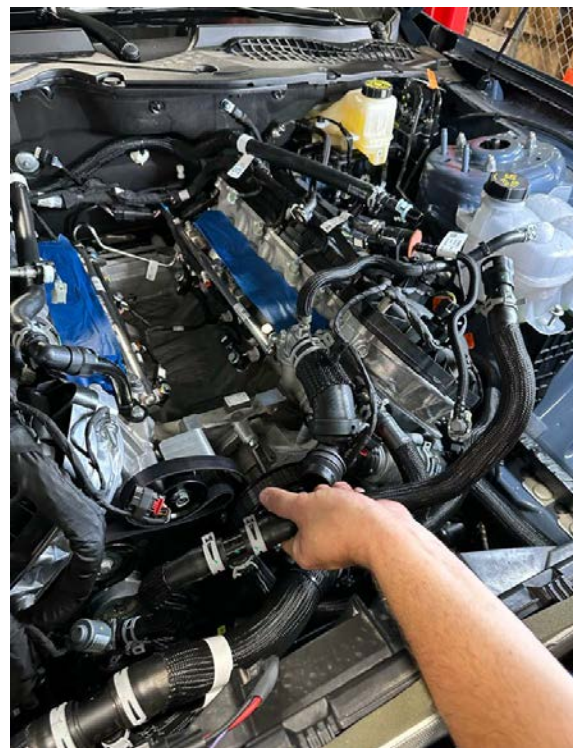

29. For Automatic cars: locate and Install hose 31-26-50-023E from step 21. Install hose to OEM heater hose located on the front side engine bay from the last step using constant tension clamps removed in the last step as shown. Route hose as shown.

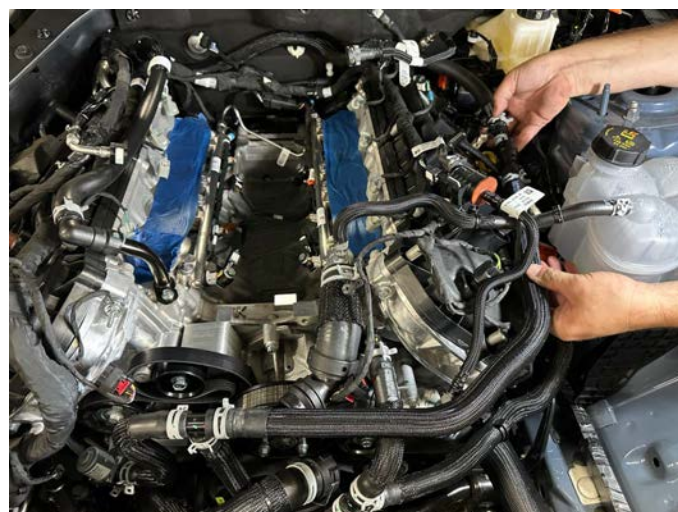

30. Install the quick connect fitting back onto the end of the heater hose (heater hose along the driver side engine bay) using a power grip clamp on the joint as shown. Re-connect the quick connect fitting to the OEM heater hose on the front side engine bay. If needed, slide the hose from the OEM zip tie on the firewall towards the front of the vehicle to connect to the heater hose.



31. Obtain the provided 2 P-clips (Item 37, page 10) from hardware kit 31-26-50-029. Use them to mount the left-hand side (driver side) heater hose onto the coils as shown.



P CLIP LOCATION 1
(CYLINDER 8)

P CLIP LOCATION 2
(CYLINDER 5)

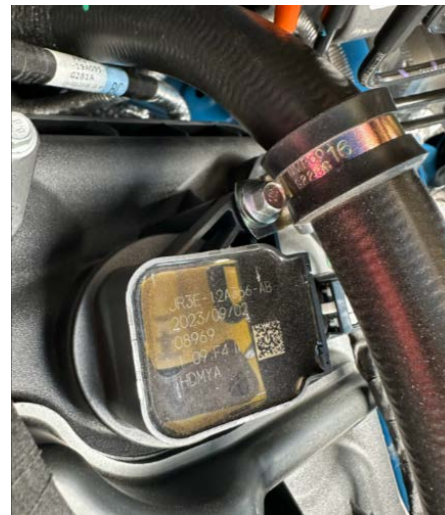

32. For Automatic cars: Make sure the heater hose is routed out of the way of the engine dip stick as shown.

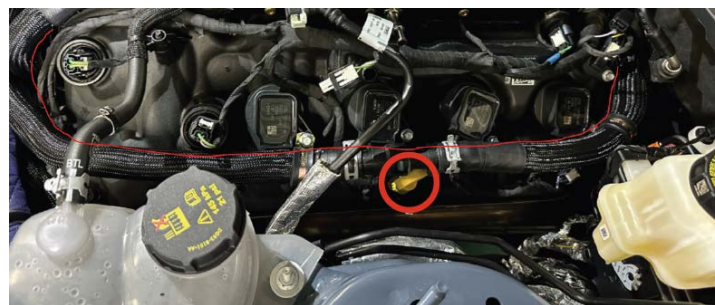

CONTINUE TO THE NEXT PAGE.

33. Verify modified heater hose line routing as shown below.



34. Unpack the supercharger assembly from the shipping box. With the help of an assistant, move and place the supercharger assembly onto a flat work surface. **MAKE SURE TO PLACE A TOWEL UNDER THE SUPERCHARGER ASSEMBLY TO PROTECT IT FROM SCRATCHES!**



ROUSH LAUNCH EDITION (SHOWN)

35. Turn the supercharger assembly upside down, and remove **ALL 8** igaskets from the stock intake manifold. Install them on the ROUSH supercharger manifold as shown. (Reference for Ford intake manifold gasket PN: JL3Z-9439-A)

Note: If the gaskets are torn or damaged, they will need to be replaced. **GASKETS ARE NOT INCLUDED IN THE KIT!**

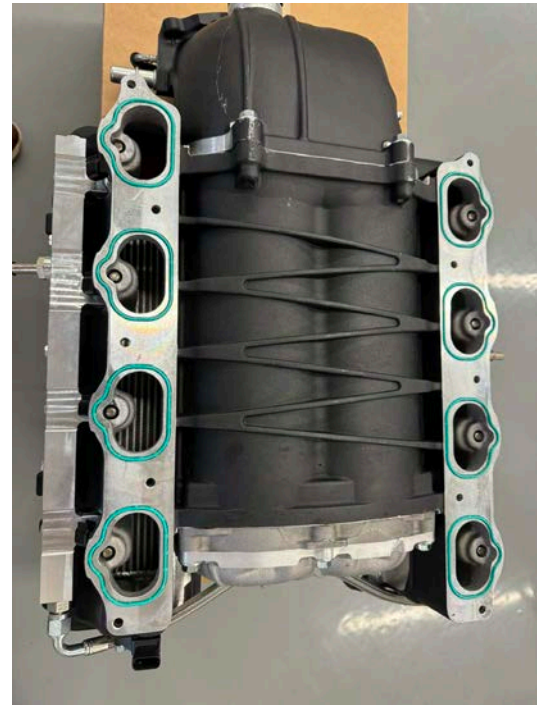

36. Remove the fuel rail pressure sensor from the stock rail, keep part for re-use. (1-1/16" deep well socket)



37. Gather the supplied copper washer (Item 50, page 10) from the hardware kit 31-26-50-029, it will be installed onto the pressure sensor as shown. Install it onto the open fuel rail port on the left-hand side (driver side) of the ROUSH intake manifold. (Lower part of the supercharger assembly) Torque to 40 Nm. (1-1/8" deep well socket)



38. Gather both of the factory clean air tubes. They will be modified in the next steps.



39. Remove the metal J clips from both MAF tubes. They will not be reused.



40. Using a grinder or cutting wheel to remove the mounting tab material from both MAF tubes at locations shown below.



41. Follow the previous step, this is what the modified clean air tube will look like.



42. Gather the stock airbox lids. They will be modified in the next step.



43. Cut $\frac{3}{4}$ " square off the airbox lids as shown, the corners near the MAF sensor need to be removed. This is to allow clearance for the MAF sensor with the clean air tubes new orientation.

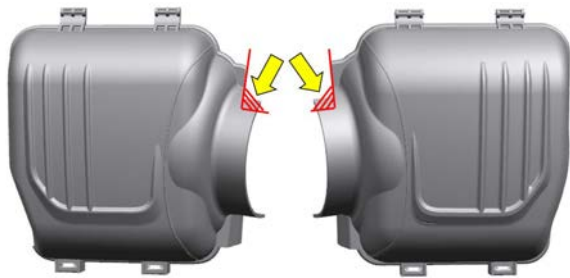

44. Remove the low temperature radiator (LTR) from the shipping box.



45. Install foam tape (PN: 90-72-00-004) from hardware kit 31-26-50-027 on both sides of the LTR and around the upper mount locations.



46. Locate the orange foam tape (Item 55, page 8) from hardware kit 31-26-50-027 and cut the tape in half, install them on the underside of the LTR U brackets (2 locations) shown on the next page.



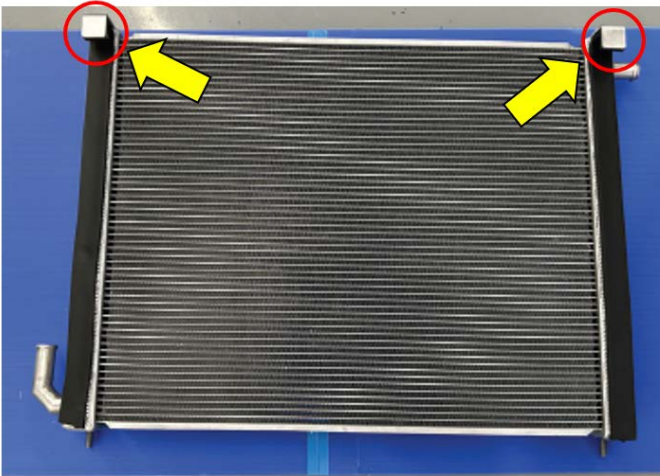

LTR U bracket Tape Locations

47. Preinstall LTR to lower charge air cooler hose (PN: 31-26-50-023D) from hose kit 31-26-50-023 as shown onto the LTR. Install the hose with Qty.1 constant tension clamp (PN: CT-3/4) from hose kit (PN: 31-26-50-023) onto the port shown.



48. Install the LTR to intercooler pump hose onto the LTR (PN: 31-26-50-023C). Use 1 constant tension clamp (orientation shown).



Detail View - LTR U bracket Tape

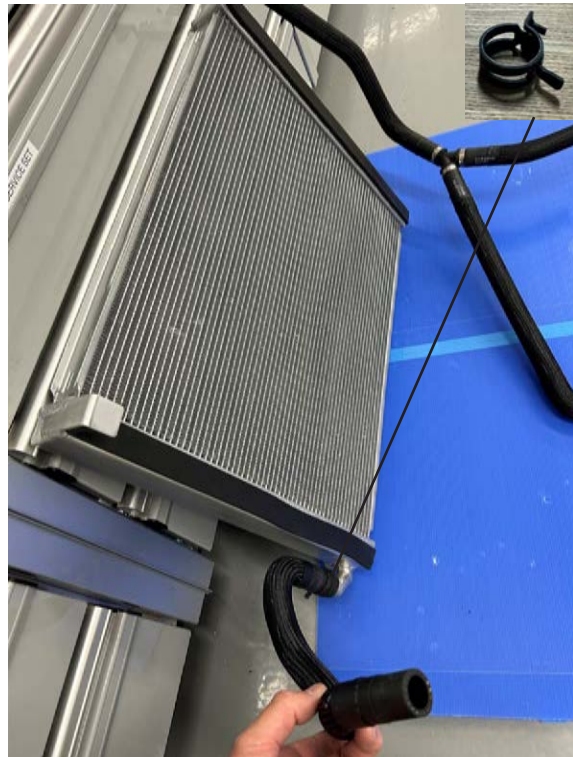



Top View Orientation - LTR Sub-Assembly

49. Locate the grommet (Item 30, page 7) and the intercooler pump (Item 29, page 7) in a cardboard box.



50. Install the grommet with the correct side facing up and orientation as shown.



Intercooler pump and grommet facing up orientation



Intercooler pump sub-assembly_Top View



Intercooler pump sub-assembly_Bottom View

51. Locate the intercooler pump bracket (Item 31, page 8) from hardware kit 31-26-50-027.



52. Remove the bolt on the sway bar mount on the left-hand side (driver side) of the engine bay. (18 mm socket)



53. Install the intercooler pump bracket and reinstall the sway bar mount bolt as shown. Torque to 110 Nm.



54. Install the provided 15 amp fuse (Item 49, page 8) from hardware kit 31-26-50-027 into the fuse spot on the intercooler pump harness (Item 48, page 8) from the same hardware kit.

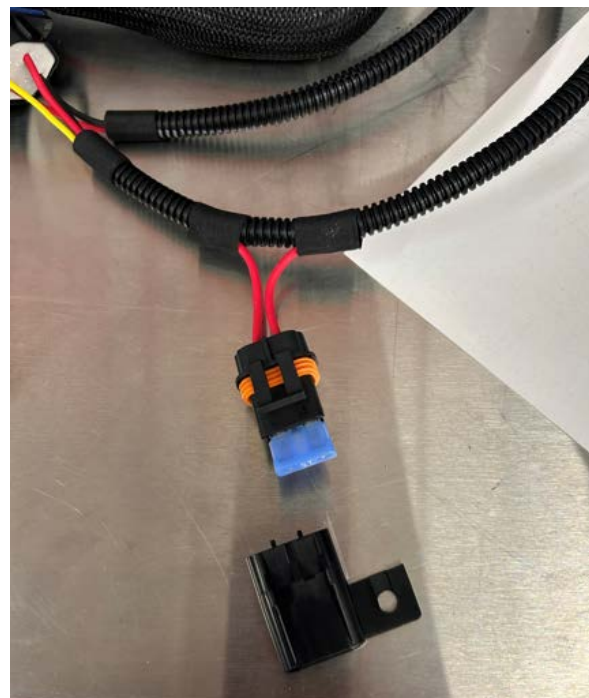

55. Pre-install the intercooler pump harness pump connector onto the intercooler pump as shown.



56. Install the intercooler pump into the location on the intercooler pump mounting bracket (from step 53), make sure it is the same orientation shown. Leave the wiring harness to the side of the engine bay.



57. Remove the air diverters on each side of the radiator. They will be modified in the next steps. (Trim tool required)

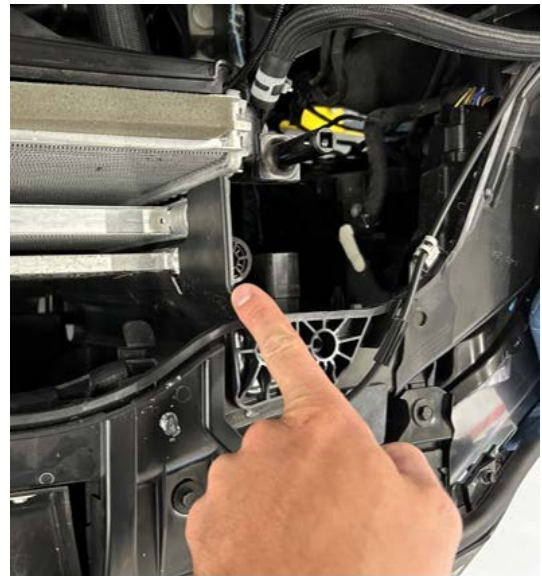

58. These are the 2 closeout parts removed from the vehicle.



59. Cut the left-hand side (driver side) closeout part on the location as shown. The mark is 4 inches from the bottom of the part.



61. Cut the right-hand side (passenger side) closeout part on the location as shown. The mark is 15 inches from the bottom of the part.



60. Cut the left-hand side (driver side) closeout part on the top section of the part as shown.



62. This is what both closeout parts will look like after the modifications.



Passenger Side

Driver Side

63. Re-install the 2 trim closeout panels (driver and passenger sides) that were modified in the previous steps. Note the correct orientation shown.



Passenger Side



Driver Side

64. Print the provided LTR BOTTOM MOUNT - DRILL TEMPLATE located on the last page (**USE 1:1 ACTUAL SCALE**). Cutout the printed template using scissors, place the template at the locations shown below and mark the holes using center punch needed for the lower LTR mounts, then drill holes using 13/32" drill bit (**SAME TEMPLATE USED ON BOTH SIDES**). Views shown below from the underside of the vehicle.



Passenger Side template location



Driver Side template location



Passenger Side cut hole



Driver Side cut hole

65. With the help of an assistant, push the radiator rearward lightly to make room to slide the LTR into position as shown.

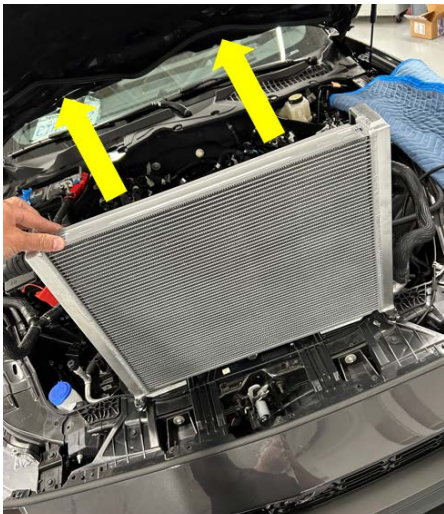

66. This is the LTR radiator slid into position. Make sure the lower mount holes are lined up and push the LTR radiator down. It should also lock onto the top of the AC condenser. Right hand side shown.

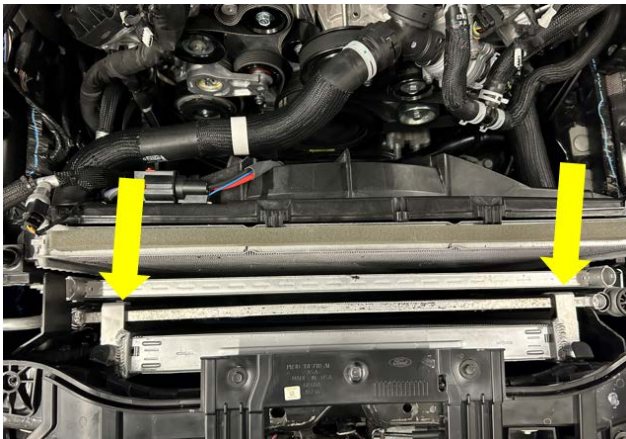

67. Obtain Qty.2 washers PN: 75-00-08-016 (Item 26, page 8) and Qty.2 lock nuts PN: 77-08-12-001 (Item 25, page 8) from hardware kit 31-26-50-027.



68. Install the washer and lock nut on the bottom 2 mounts for the LTR (washer goes under the lock nut). Install them until they bottom out. Torque to them to 15 Nm.



Passenger Side



Driver Side

69. Connect the LTR to intercooler pump hose from the LTR to the side of the intercooler pump hole location shown below. Use a $\frac{3}{4}$ " constant tension clamp to secure the connection.



71. Remove the harness retention clip that is located on the rear right-hand (passenger side) cam cover. Reinstall it with a new zip tie as shown.

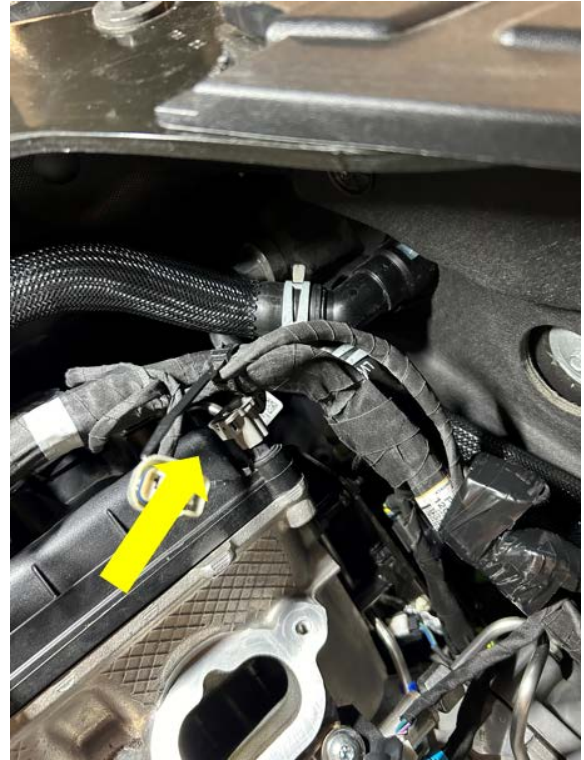

70. Remove the quick release clip located on the right side (passenger side) of the engine if it is still installed on the heater hose hard line shown.



72. Remove the remaining stud mounted harness retention clips from the harness on both sides of the cam covers as shown.

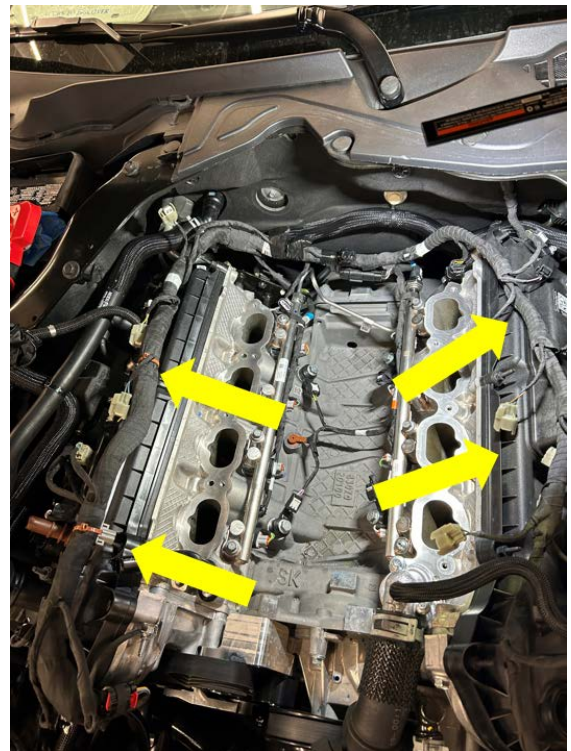

73. Remove the harness retention clip and zip tie from the left-hand side (driver side) rear cam cover location. Take one of the side mounted zip tie retention pieces removed from the previous step and install it in this location shown.

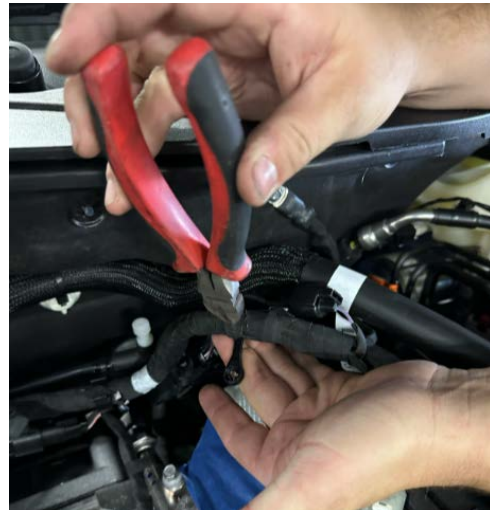

74. If equipped, cut off 3 OEM zip ties from the electrical harness located on the left side (driver side) of the engine bay.



ROUSH LAUNCH EDITION (SHOWN)

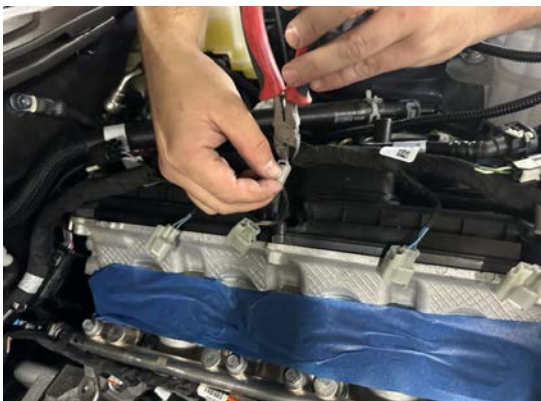

75. Remove the 18 bolts securing the supercharger lid to the lower supercharger manifold assembly. (12 short bolts around the perimeter, 6 long bolts down the center) (10 mm socket)

76. Remove the bypass hose from the port on the side of the inlet and lift to remove the supercharger lid.

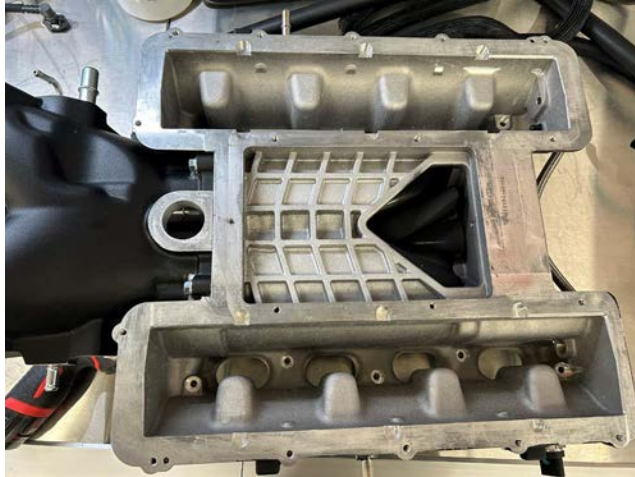

Passenger Side



77. From the supercharger assembly, retrieve the 2 fuel rail ports taped to the side in a plastic bag. Install them on the fuel rail holes on both driver and passenger side. Torque to 30 Nm.



Driver Side

78. Make sure the valley and intake ports are clean. Remove the tape from the intake ports. Note: Verify nothing is in the intake ports before proceeding.

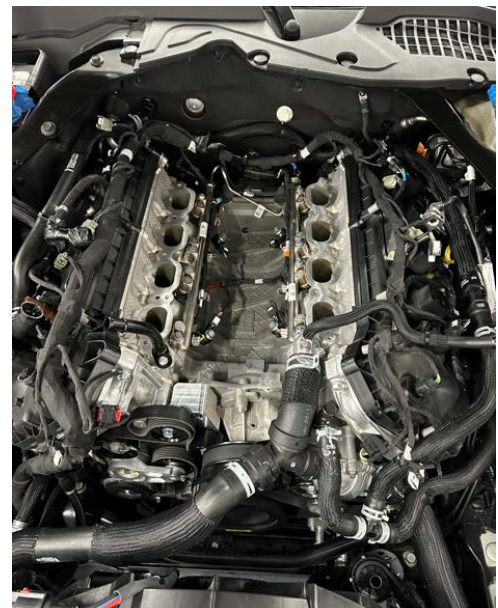

79. With a helper, install the lower supercharger manifold into the engine valley and onto the intake ports with the correct orientation as shown. Route the electrical harness above the SAE quick connect fuel lines.



80. Lift each side of the supercharger up and connect the fuel injector electrical connectors (4 per side). Connect the MAP sensor on the back side of the supercharger.

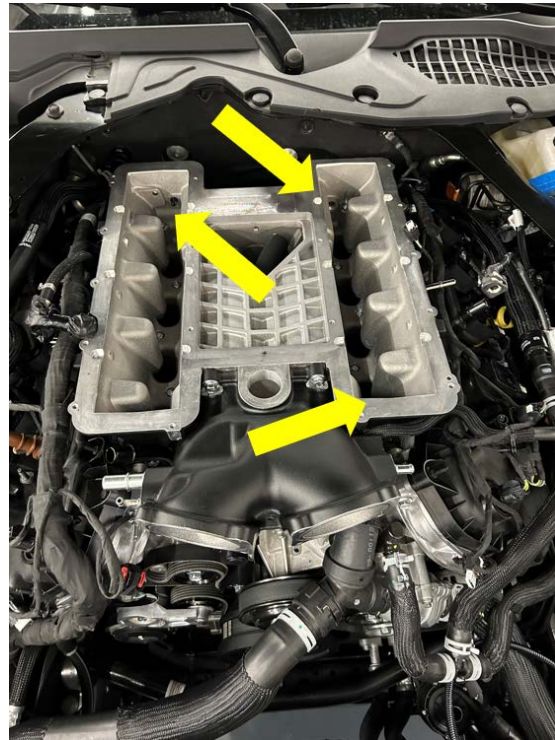

Note: Yellow arrows are to show M6x75mm bolt locations.



81. Gather the provided 3 bolts M6x75mm (Item 45, page 9) and 7 bolts M6x30mm (Item 44, page 9) (supercharger to cylinder head bolts) from hardware kit 31-26-50-029. Using blue Loctite on the bolts, install and torque them to 10 Nm then to 16 Nm. Follow torque sequence shown.

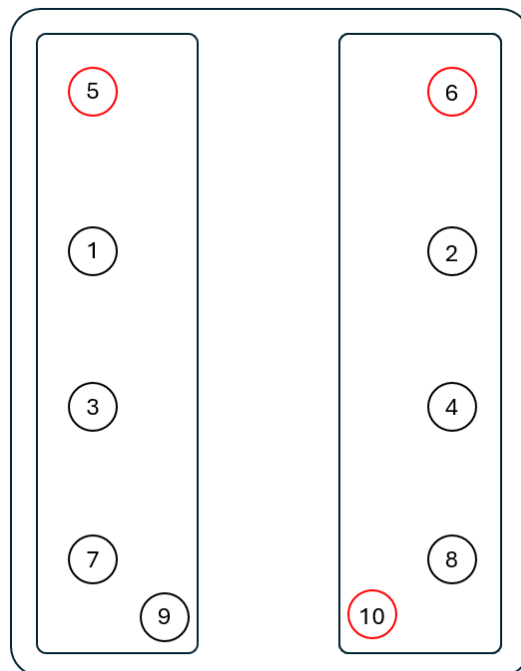

M6x75mm bolt locations are red circled

Torque Sequence - Supercharger To Cylinder Heads

Note: There are 5 bolts per side.



82. Connect the electrical connector on the fuel pressure sensor on the left side (driver side) fuel rail.



84. Locate the provided supercharger pulley belt PN: K060710 (Item 23, page 5) and loop it around the supercharger pulley on the lower supercharger manifold. Tighten the 4 M6x16mm supercharger pulley bolts and use blue Loctite.

Note: The bolts will be torqued in step 86.

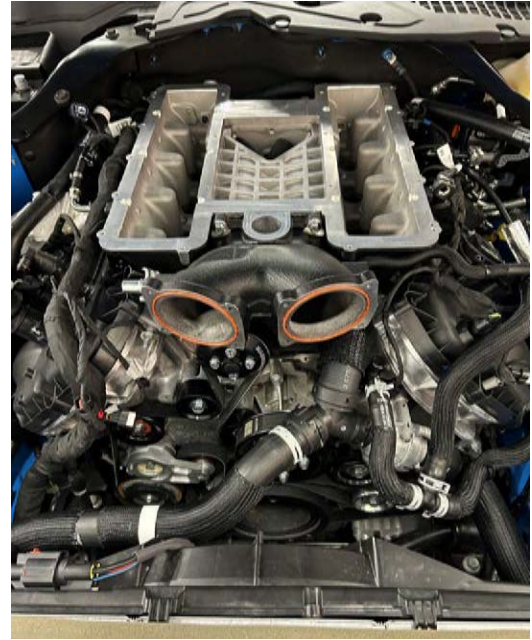

83. Remove the factory intake manifold throttle body gaskets from the factory intake manifold.

(Reference for Ford intake manifold throttle body gasket PN: PR3Z-9E936-A)

Note: If the gaskets are torn or damaged, they will need to be replaced. GASKETS ARE NOT INCLUDED IN THE KIT!



85. Use a 3/8 breaker bar and rotate the tensioner clockwise to route the belt back around the top idlers as shown (To secure the belt into position 1).

Note: Reference ROUSH supercharger pulley diagram on the last page of the manual.

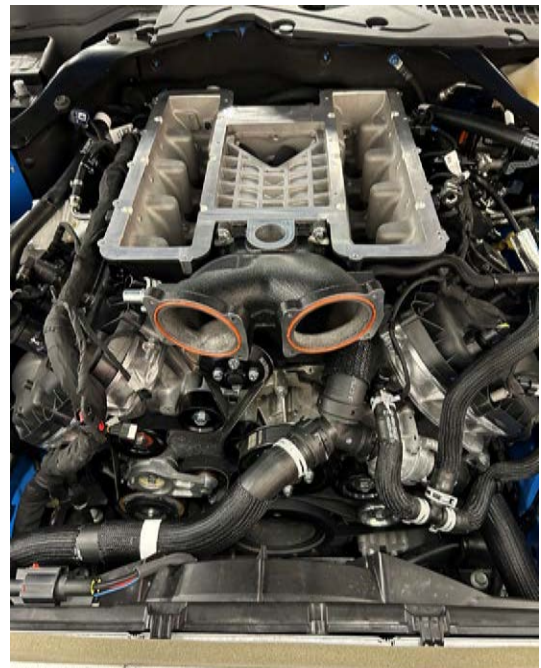

86. Torque the 4 supercharger pulley bolts to 12 Nm.



88. Re-install the 2 stock throttle bodies removed from the factory intake manifold onto the supercharger manifold with the correct orientation as shown. Torque the bolts to 12Nm. (8mm socket)



87. Install the supercharger lid onto the supercharger manifold. Use the 18 bolts removed in step 75. Torque bolts to 12 Nm. Note: Torque sequence is shown below.



89. Connect the electrical connectors from both sides of the engine harness that goes to the throttle bodies. Note: left hand side (driver side) requires tape removal from the harness to spin the connector around.

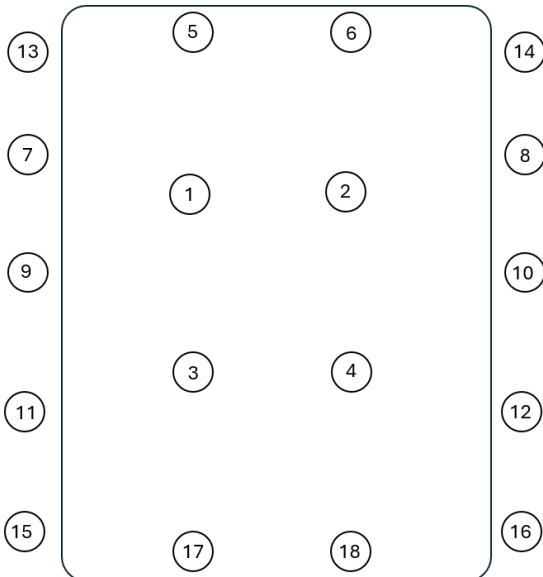

Torque Sequence - Supercharger Lid



90. Connect the left-hand side (driver side) fuel supply line to the left-hand side (driver side) fuel rail port on the supercharger manifold. Verify it clicks and is engaged onto the fitting.



91. Connect the right-hand side (passenger side) fuel supply to the DI pump. Make sure it clicks and is engaged onto the fittings.

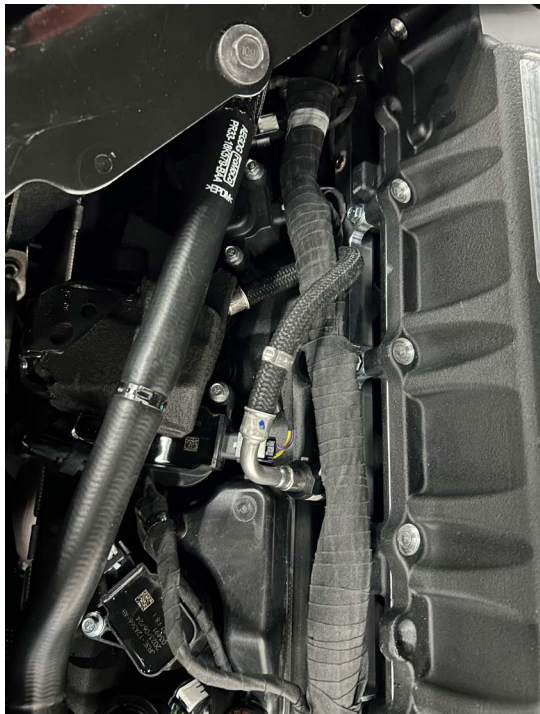

92. Gather the 3/4" quick connect fitting (Item 36, page 6) and hose part number 31-26-50-023F from hose kit 31-26-50-023. This hose will be used for the passenger side heater core return hose.



93. Cut 1 inch off of the hose on the side with the bend as shown.



94. Install the quick connect fitting onto the end of the hose from the last step as shown. Using a power grip clamp (Item 40, page 8) to retain the fitting. Using a heat gun apply heat to the clamp evenly until it has shrunk around the hose and is shiny.



96. Install the provided protective sheaving over the hose section on the right side (driver side) of the engine bay. Use the heat shrink to hold it into place.



95. **For Automatic cars:** Hold the new heater hose extension line up next to the old heater hose on the right side (driver side) of the engine bay. Cut the heater hose and install the hose mender (Item 36, page 6) to connect the new hose to the end of the old hose.

For Manual cars: You will need to make sure you retain the orifice in the factory heater hose. You may need to trim the newly supplied heater hose extension shorter to retain the orifice in the old line.



97. Locate the supplied PCV hose (Item 33, page 10) from hardware kit 31-26-50-029.



98. Install the PCV hose on the right-hand side (passenger side) cam cover to the right-hand side (passenger side) side port on the supercharger.

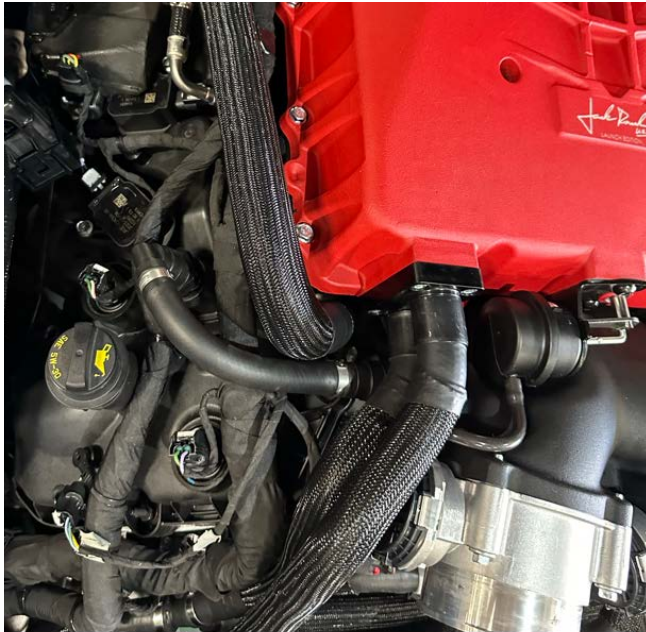

99. Install the bypass hose onto the 90 degree fitting on the right-hand side (passenger side) of the supercharger.



CONTINUE TO THE NEXT PAGE.

INTERCOOLER CIRCUIT DIAGRAM FOR REFERENCE ONLY

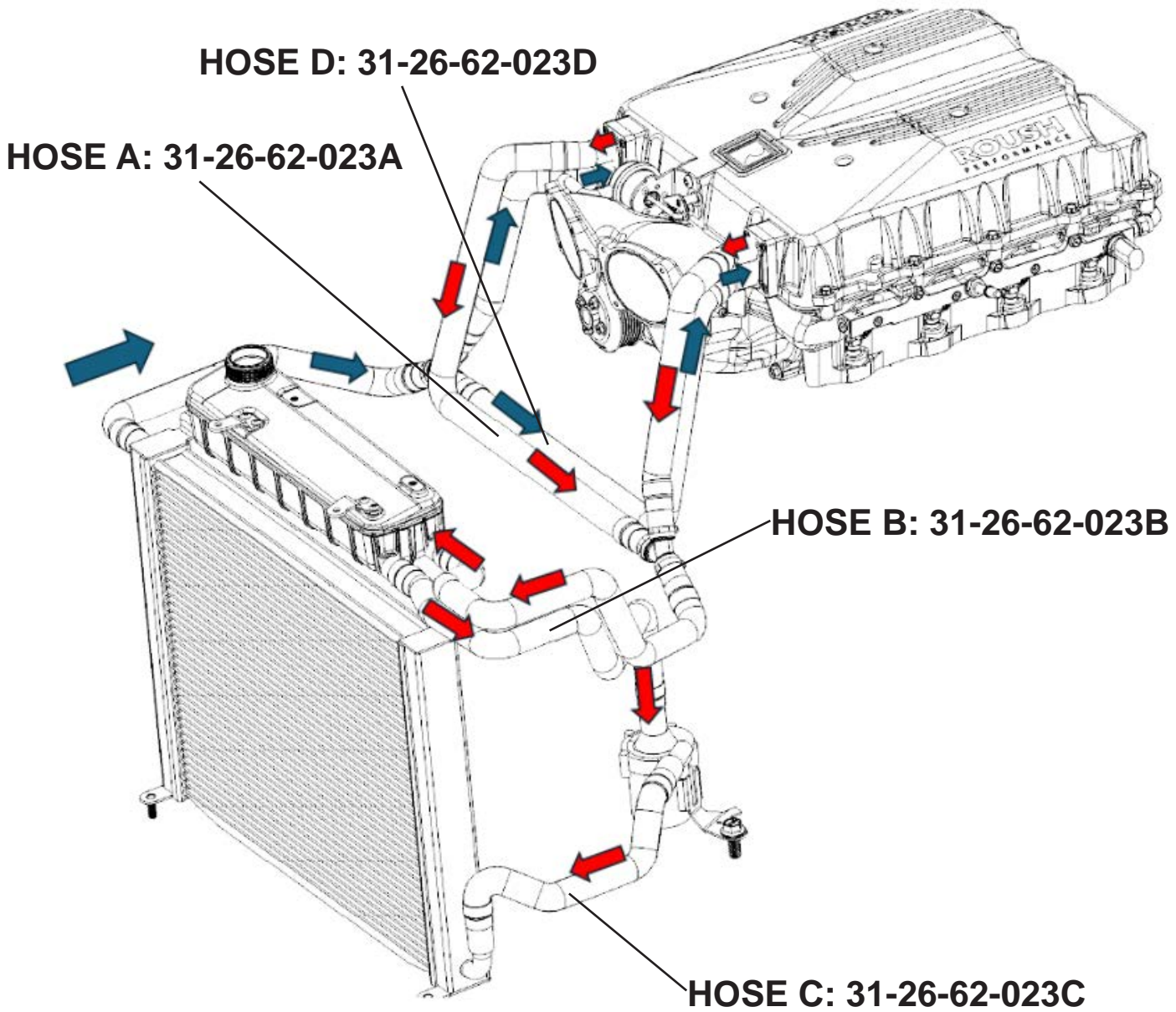

CONTINUE TO THE NEXT PAGE.

100. Gather the supplied hose part number: 31-26-50-023B from hose kit 31-26-50-023. This hose will be used to connect intercooler pump to the reservoir degas bottle.



101. Route the hose 31-26-50-023B (from the last step) as shown and install the hose onto the top of the intercooler pump. Use a $\frac{3}{4}$ " constant tension clamp from hose kit 31-26-50-023 to secure the hose connection as shown.

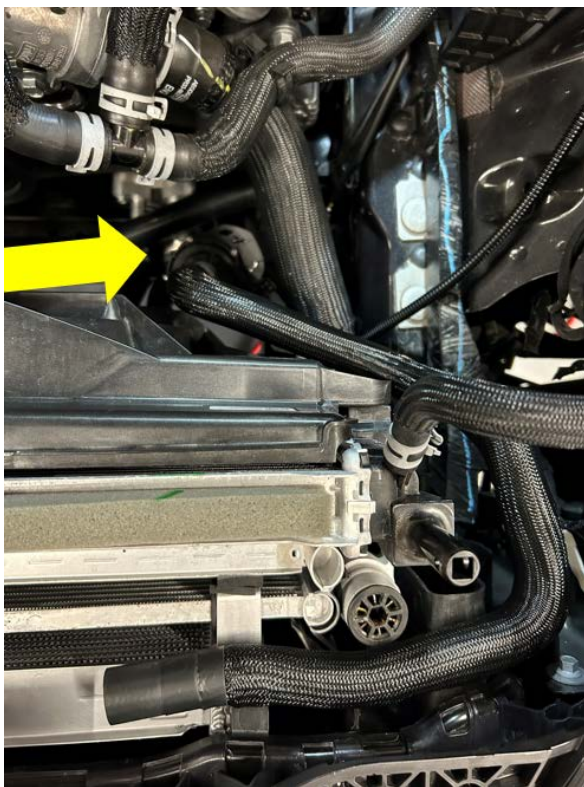

102. Connect the lower charge air cooler hose from the right-hand side (passenger side) of the LTR to the bottom 2 ports of the supercharger assembly as shown. Route the hose as shown. Use 2 power grip clamps (Item 40, page 8) to secure the hoses to the supercharger assembly.



103. Gather the supplied hose 31-26-50-023A from hose kit 31-26-50-023. This will be used to connect the top 2 ports of the supercharger assembly to the reservoir degas bottle.



104. Install hose 31-26-50-023A onto the top 2 ports of the supercharger lid. Use 2 power grip clamps (Item 40, page 8) to secure the hose connections to the supercharger assembly. The hose will route around to the left-hand side (driver side) of the radiator core support as shown. (This hose will be connected to the reservoir degas bottle in a later step)



105. Verify top and bottom ports of the supercharger shown below. Note: To verify ALL hose connections, go to the last page of the manual and see the supercharger assembly - hose diagram.



106. Remove the 2 front fascia support bolts from the vehicle front grille area and save for re-use. (10 mm socket)

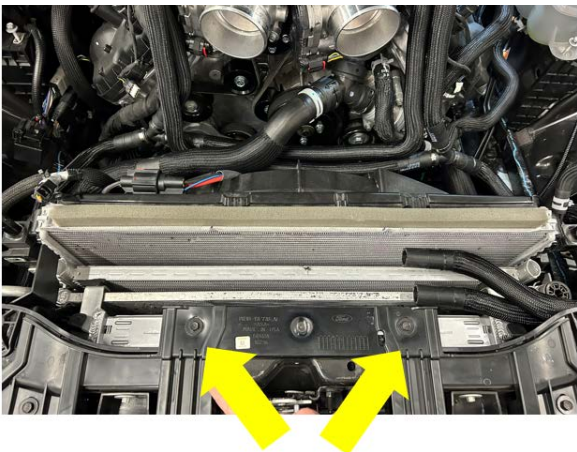

107. Locate the provided reservoir degas bottle (Item 27, page 6) Note: Remove the reservoir cap (Item 28, page 6) and save for install later.

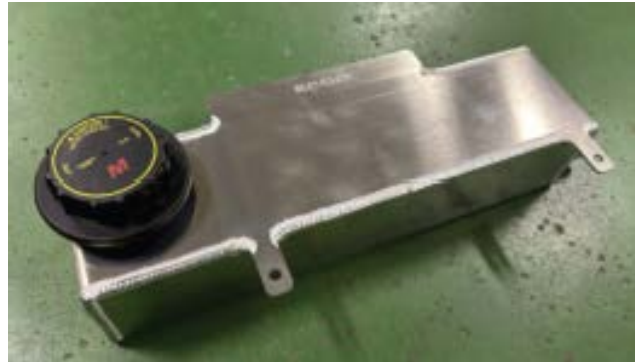
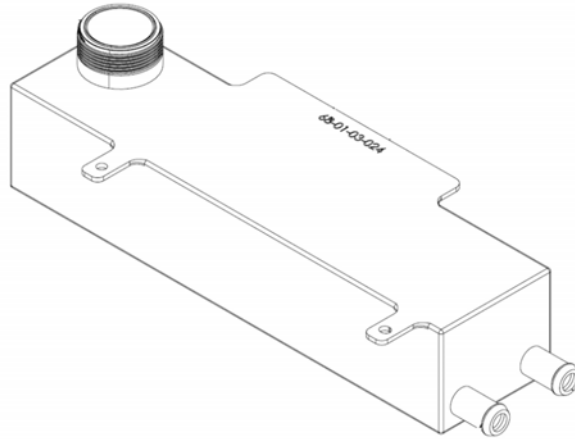

108. Turn the reservoir (Item 27, page 6) upside down and install a piece of foam tape (Item 56, page 8) from hardware kit 31-26-50-027 on the flat lip location as shown.



109. Install the reservoir (Item 27, page 6) just behind the vehicle front grill area as shown. The tank goes between the core support and the fascia bracket. You will need to push the radiator towards the engine to install the reservoir. Reinstall the 2 bolts removed in step 106, torque to 12 Nm. (10 mm socket)



110. Route the intercooler pump electrical harness towards the right side (passenger side) along the intercooler hoses as shown (In front of the reservoir) .

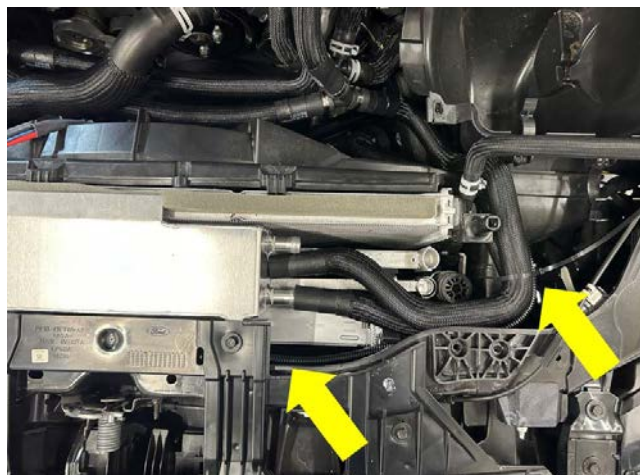

111. Install the tank inlet and outlet hoses to the reservoir. Use 2 supplied 3/4" constant tension clamps from hose kit 31-26-50-023 to secure the hose connections to the reservoir (**Inlet Hose – Flow in from supercharger top 2 ports, Outlet Hose – Flow out to the intercooler pump top port**).

Note: To verify ALL hose connections, go to the last page of the manual and see the supercharger assembly - hose diagram.

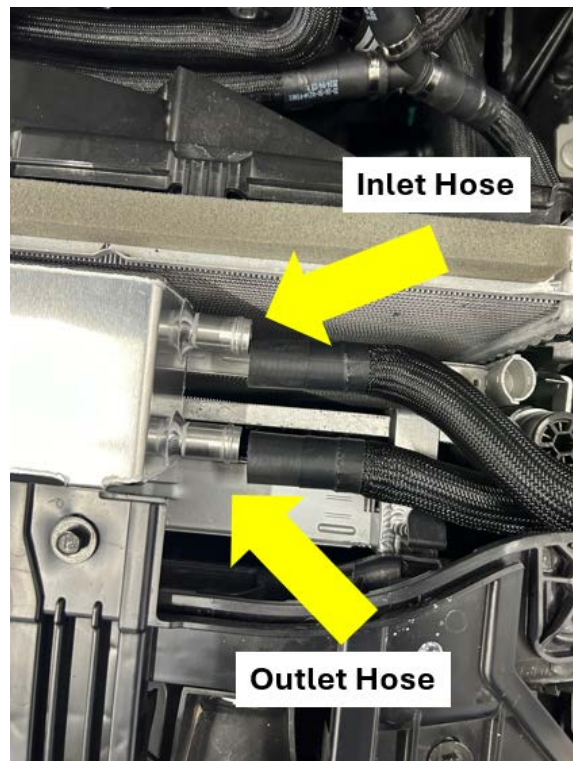

112. Remove the J clip from the lower airbox trays. They are not needed and do not need to be reinstalled.

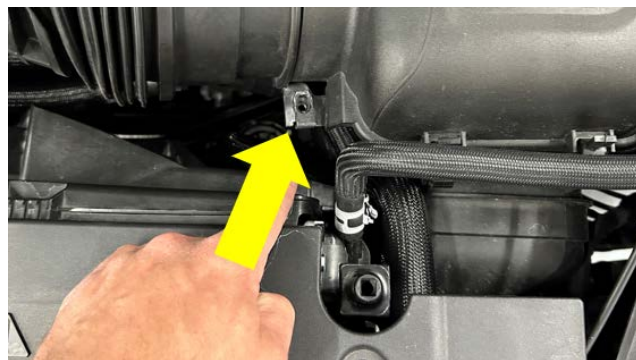

113. Reinstall the lower air box tray on the left-hand (driver side) side of the engine bay. (10mm socket)



116. Route the intercooler electrical harness relay over to the fuse box area.

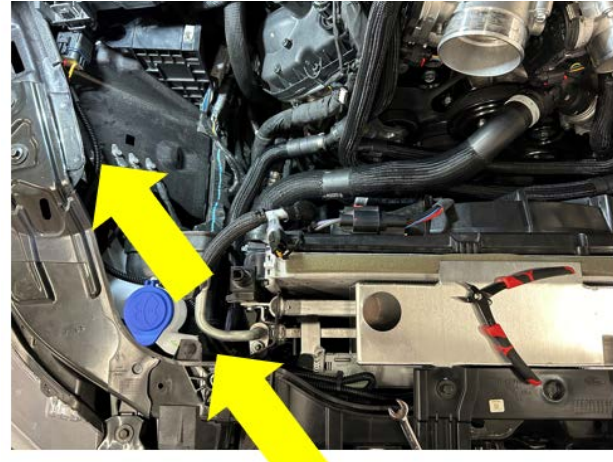

114. Reinstall the right-hand side lower airbox duct.



117. Remove the m6 bolt holding the fuse panel in this location. (10mm socket) Reinstall the bolt and mount the relay as shown. The fuse holder can be zip tied to the relay.

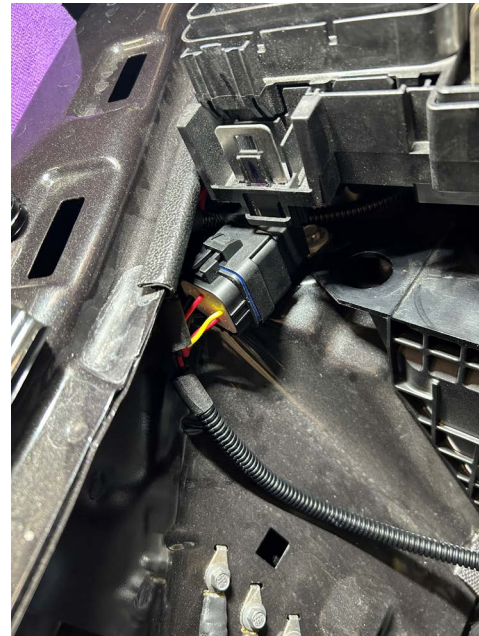

115. Continue routing the intercooler electrical harness towards the right side (passenger side) along the core support (In front of the reservoir).

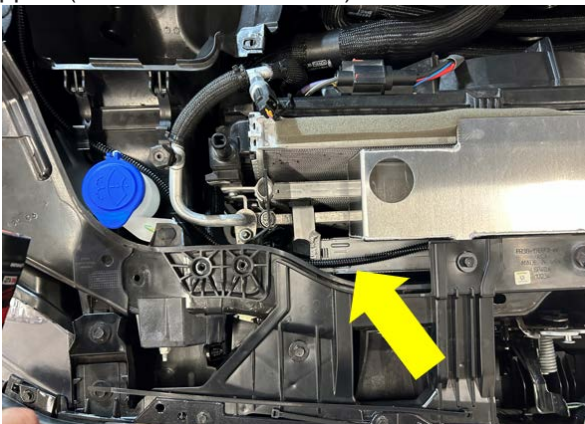

118. Remove the fuse panel cover.



119. Route the intercooler electrical harness power line along the fuse panel and connect the eyelet to the power terminal shown.



121. Remove the 10 AMP fuse from the fuse box shown (F21 location). Install the intercooler electrical harness fuse jumper onto the fuse and reinstall the fuse.



120. Route the intercooler electrical harness ground terminal to the ground bolt on the passenger fender under the air box as shown. Install the ground to the location shown. (8mm socket)

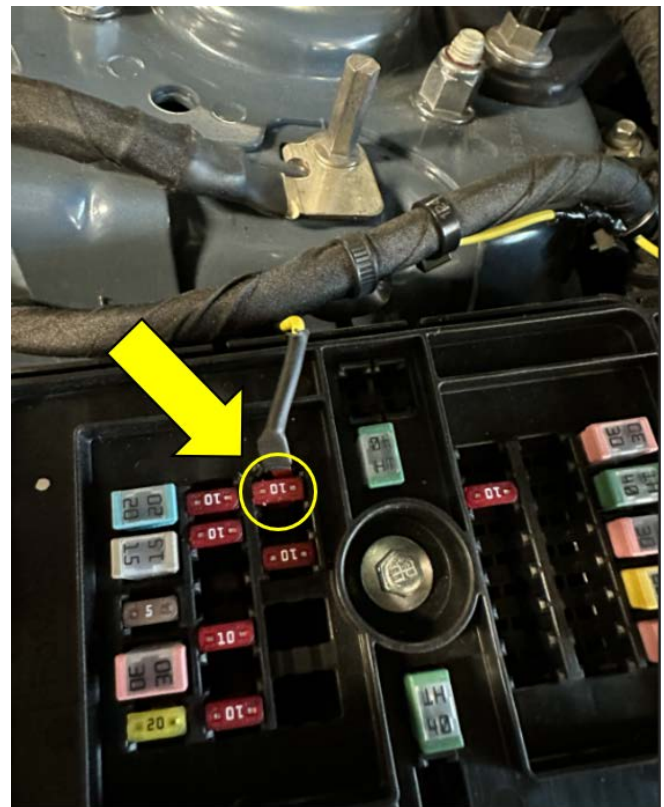

122. Cut a notch in the fuse panel lid as shown. This is to allow the trigger wire to pass thru the fuse panel without getting pinched. Re-install the fuse panel cover onto the fuse box.

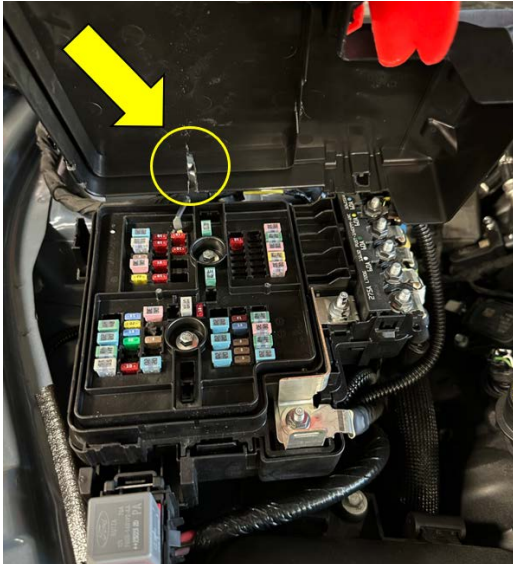

123. Intercooler electrical harness trigger wire routing shown.



124. Reinstall the lower airbox tray on the right-hand side (passenger side) with the correct orientation shown. (10mm socket)



125. Take the left-hand side (driver side) clean air tube (MAF tube). Remove the lower factory air tube connector and clamp as shown.



126. Install the new clean air tube plug (Item 47, page 10) found in hardware kit 31-26-50-029 onto the air filter with clean air tube and clamp (Item 46, page 10) from the same hardware kit using the provided plier tool as shown.

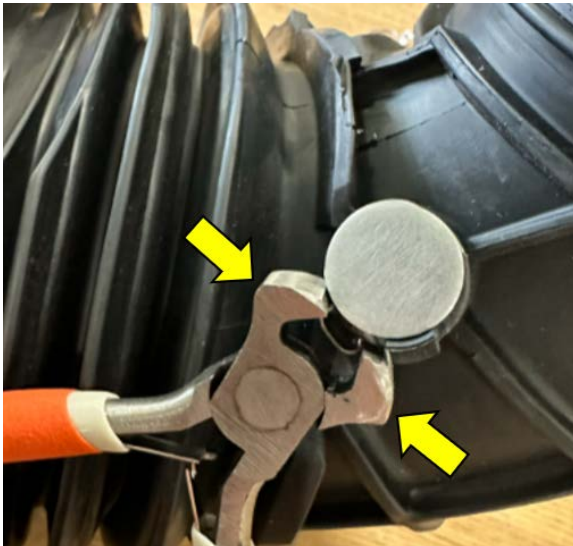

127. Rotate the air filter on the clean air tube so it matches the orientation required on the lower airbox tray as shown. Note: the clean air tube needs to rotate upwards.



128. Tighten the air filter to the clean air tube. Then tighten the clean air tube to the throttle body. Torque to 4.1 Nm.



129. Repeat the previous steps for the right-hand side (passenger side) clean air tube. Note: rotate clean air tube and air filter to the correct orientation, then tighten all clamps.



130. Install both left and right air box lids onto the correct side lower air box trays, re-clip the latches on both airbox lids as shown. Note: 2 latches per lid.



131. Locate the left-hand side (driver side) heater hose mount. Take the grommet off the evap solenoid mount. Note: picture shown below is off the vehicle.



133. Locate the takeoff EVAP solenoid.



132. Install the EVAP solenoid grommet onto the metal bracket (Item 43, page 10) supplied in hardware kit 31-26-50-029.



134. Cut the tube off the EVAP solenoid as shown. It will not be reused.



135. Install the provided EVAP hose (Item 34, page 10) from hardware kit 31-26-50-029 onto the EVAP solenoid barb. Secure it using an EVAP hose clamp (Item 35, page 10) from the same hardware kit using the provided plier tool as shown.



137. Slide the EVAP solenoid onto the bracket as shown.

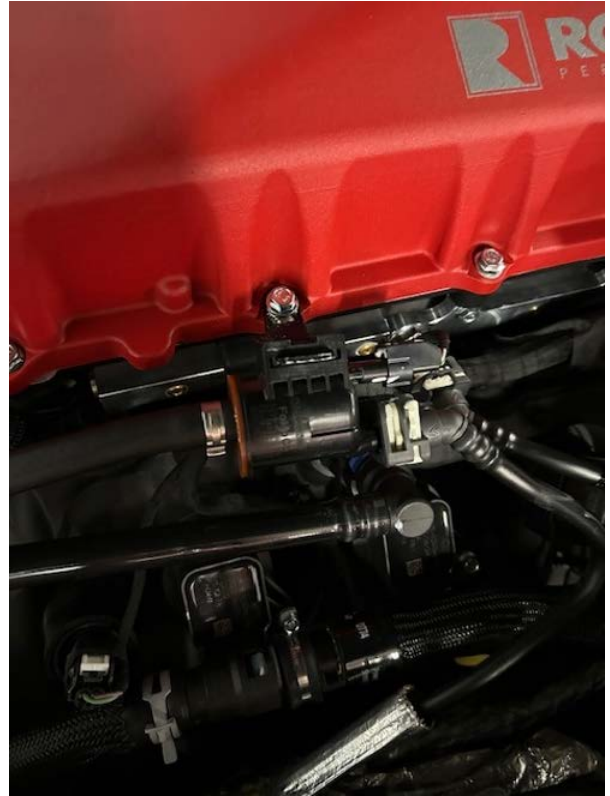

136. Remove the bolt from the supercharger lid at cylinder number 6 location. Install the EVAP bracket as shown. Torque the bolt to 12 Nm.

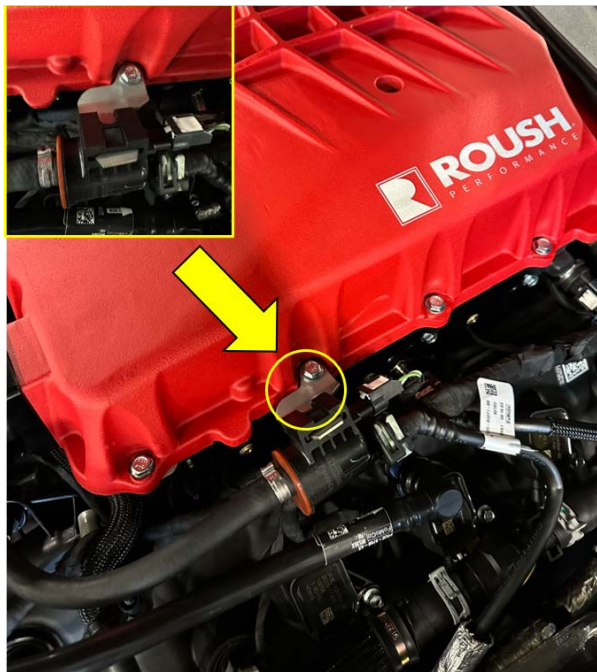

138. Connect the electrical connectors and the fitting from the engine harness to the EVAP solenoid.

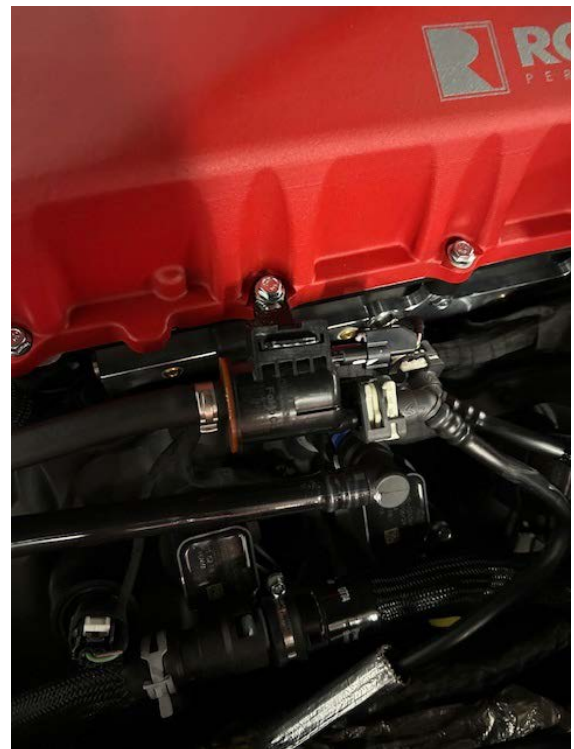

139. Route the EVAP hose to the barb on the left-hand side (driver side) of the supercharger inlet using EVAP hose clamp (Item 35, page 10) from hardware kit 31-26-50-029.



140. Reinstall the takeoff PCV hose from the left-hand camshaft cover to the clean air tube.



Step 140 Continued: Before installation, using a heat gun to apply heat to the PCV hose evenly and bend the PCV hose straight slightly as shown, this will ease the installation process.



141. Using a vacuum fill tool to check for leaks and refill the engine cooling system with coolant. (Reference for Ford coolant PN: VC13DLG)



142. Use the same vacuum fill tool and check for leaks on the reservoir degas bottle (supercharger intercooler system). If no leaks are found, fill the system using the same tool. **The required fluid level is at 1/8 inch from the top of the tank as shown.**

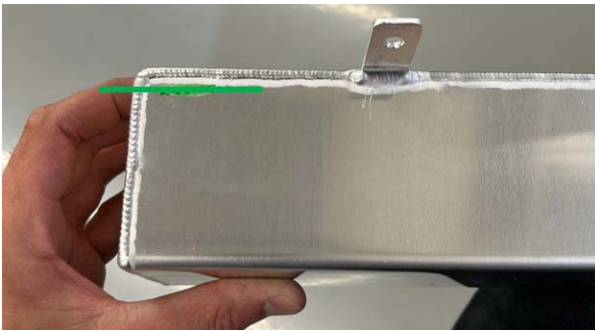

Fill line for reference

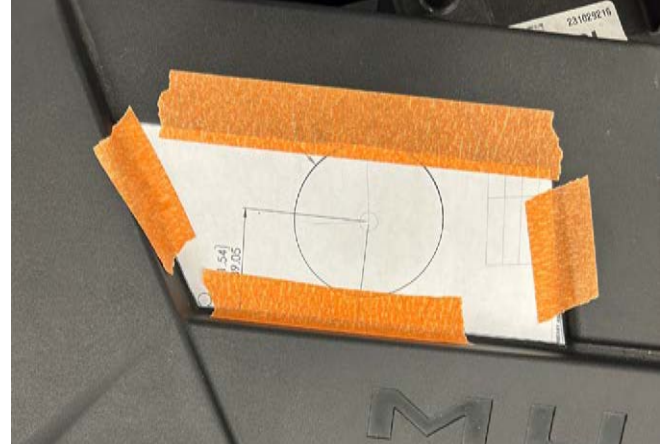

145. Verify hole cut as shown below.



143. Locate the OEM radiator closeout panel.



144. Using the DEGAS BOTTLE - DRILL TEMPLATE (on the last page this manual) to drill a 2 1/4" hole with the same size hole saw bit to cut the hole out.



146. Reinstall the closeout panel onto the vehicle, then install and tighten reservoir cap onto the degas bottle as shown.



147. Reinstall the underside closeout panel.



148. On the right side (passenger side) of the supercharger assembly, Use provided zip ties (Item 41, page 8) to tie OE harness and hoses together, then use 2 hose clips (Item 38, page 10) to clip and separate OE harnesses as shown.

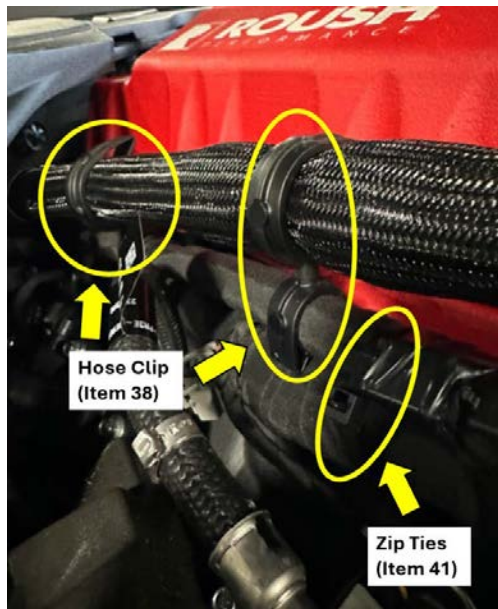

149. Reconnect the vehicle battery power and ground cables. (10 mm socket) Reinstall the battery closeout panel on the battery tray.



150. **Change oil with 5W-50 and recommended factory oil filter. DO NOT START VEHICLE!!!**



151. Provide RETAILDOC-AB (Item 53, page 9) to the end customer for customer warranty registration.



To register your Roush supercharger kit, go to:
<https://support.roushperformance.com/s/article/ROUSH-Performance-Warranty-Information>

Continue To Section C - Module Programming
YOU MUST INSTALL ROUSH CALIBRATION AFTER INSTALLATION IS COMPLETE, FAILURE TO DO SO WILL VOID YOUR VEHICLE WARRANTY!

SECTION C – MODULE PROGRAMMING_RDT SOFTWARE DOWNLOAD

The following pictured steps will guide you through the module programming - RDT2 software download process.

Note: RDT2 software requires an internet connection to flash the vehicle.

1. Enter “https://portal.rdtcloud.com/” into your web browser’s address bar and proceed to the website. Click on “CREATE AN RDT2 ACCOUNT”. Note: For existing users, click on “LOG IN” and proceed to Step 7.

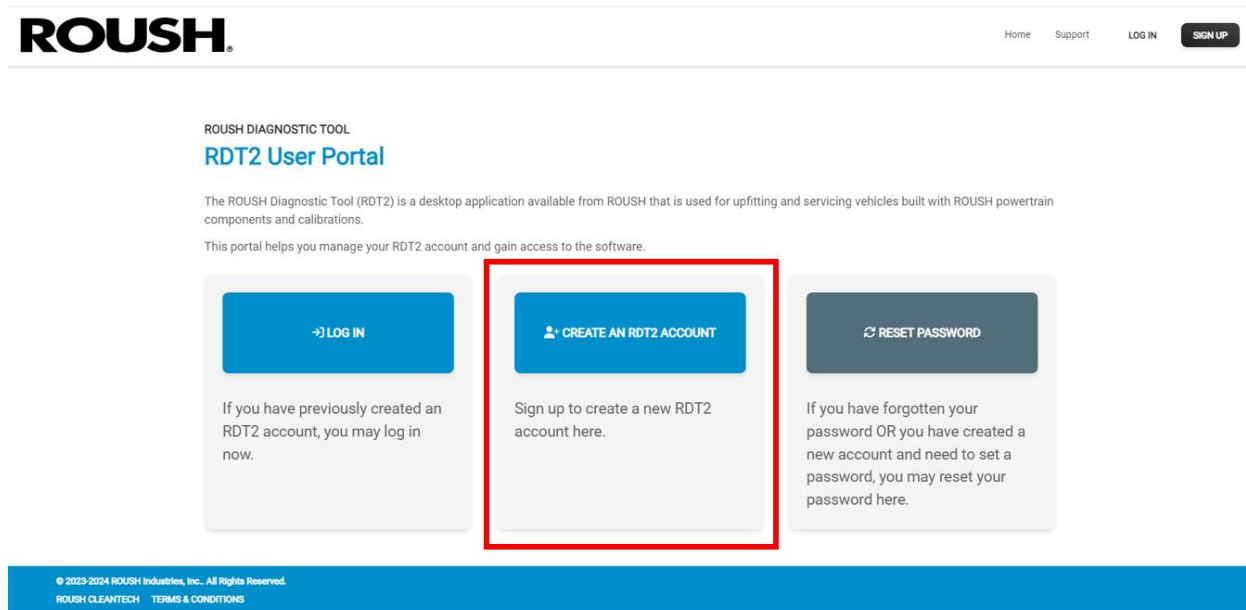

2. Once the web page opens, click on “CREATE AN RDT2 ACCOUNT FOR ROUSH PERFORMANCE VEHICLES”.

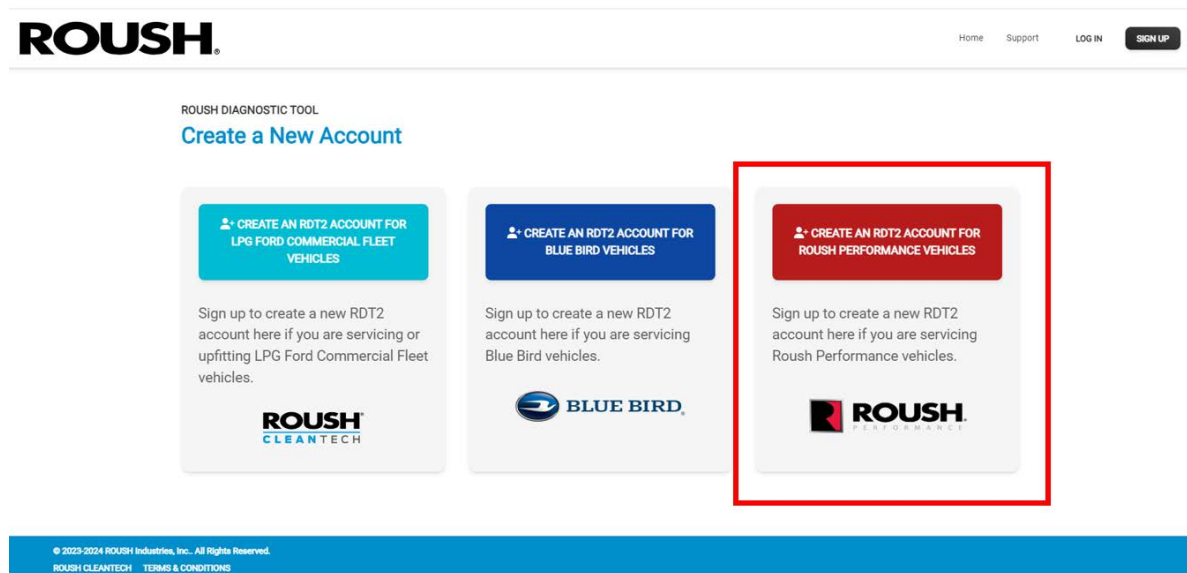

3. Once the web page opens, enter account information and your information, then click on “SIGN UP FOR AN ACCOUNT”.

ROUSH DIAGNOSTIC TOOL
Sign up for an account: Roush Performance

ACCOUNT INFORMATION
Tell us about why you need this account and how you are going to use RD72.

Required Account Type
RPP Customer

YOUR INFORMATION

Email Address*

Phone Number*

First Name* Last Name*

Street Address*

Street Address Line 2

City* State* ZIP*

SIGN UP FOR AN ACCOUNT

Already have an account? [Log In](#)

© 2023-2024 ROUSH Industries, Inc. All Rights Reserved.
ROUSH CLEANTECH TERMS & CONDITIONS

4. Once the web page opens, Verify your email address is correct, then set initial password by clicking on “REQUEST RESET CODE”.

ROUSH DIAGNOSTIC TOOL
Set Initial Password

To verify your account and set a password, simply request a code and we will send you an email. Remember to check your spam folder!

Email Address*

CANCEL REQUEST RESET CODE

© 2023-2024 ROUSH Industries, Inc. All Rights Reserved.
ROUSH CLEANTECH TERMS & CONDITIONS

5. Check your email account for the 6 digits verification code from ROUSH Diagnostic Tool. Once the web page refreshes, copy and paste it onto “Confirmation Code” and set your Password by entering it into “New Password” and “Confirm New Password”. Click on “RESET PASSWORD”.

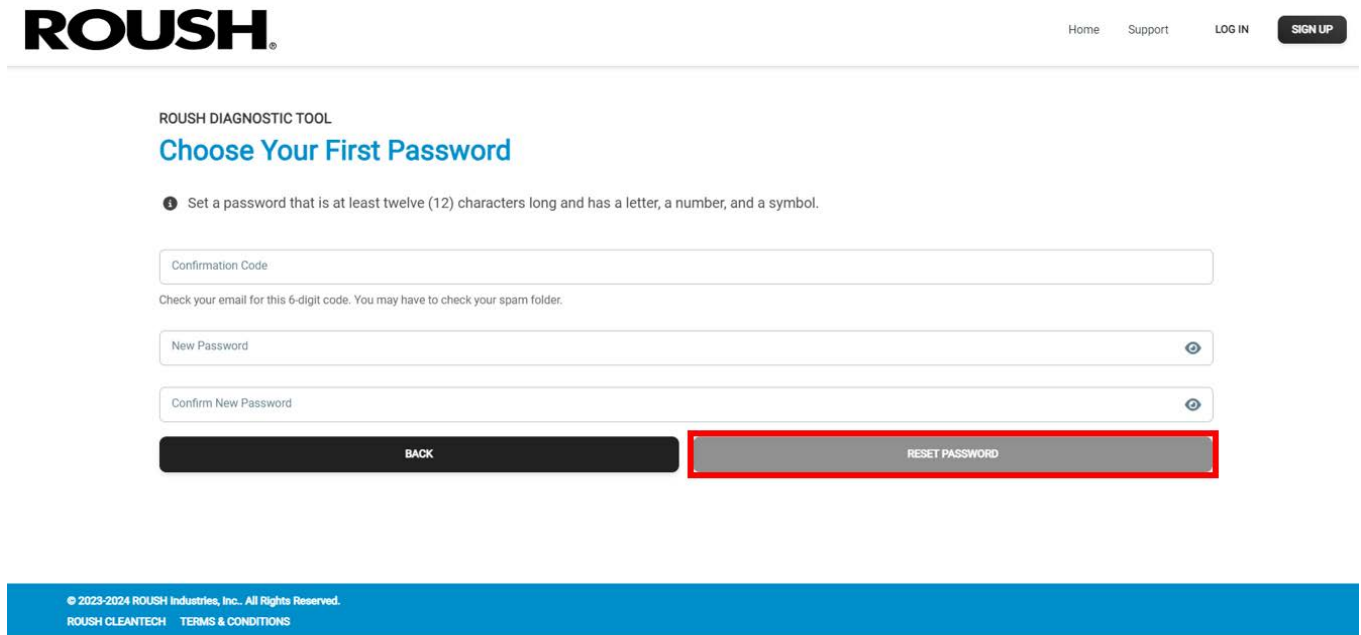

ROUSH DIAGNOSTIC TOOL

Choose Your First Password

1 Set a password that is at least twelve (12) characters long and has a letter, a number, and a symbol.

Confirmation Code

Check your email for this 6-digit code. You may have to check your spam folder.

New Password

Confirm New Password

BACK RESET PASSWORD

© 2023-2024 ROUSH Industries, Inc. All Rights Reserved.
ROUSH CLEANTECH TERMS & CONDITIONS

6. Once the web page refreshes, click on “LOG IN”.

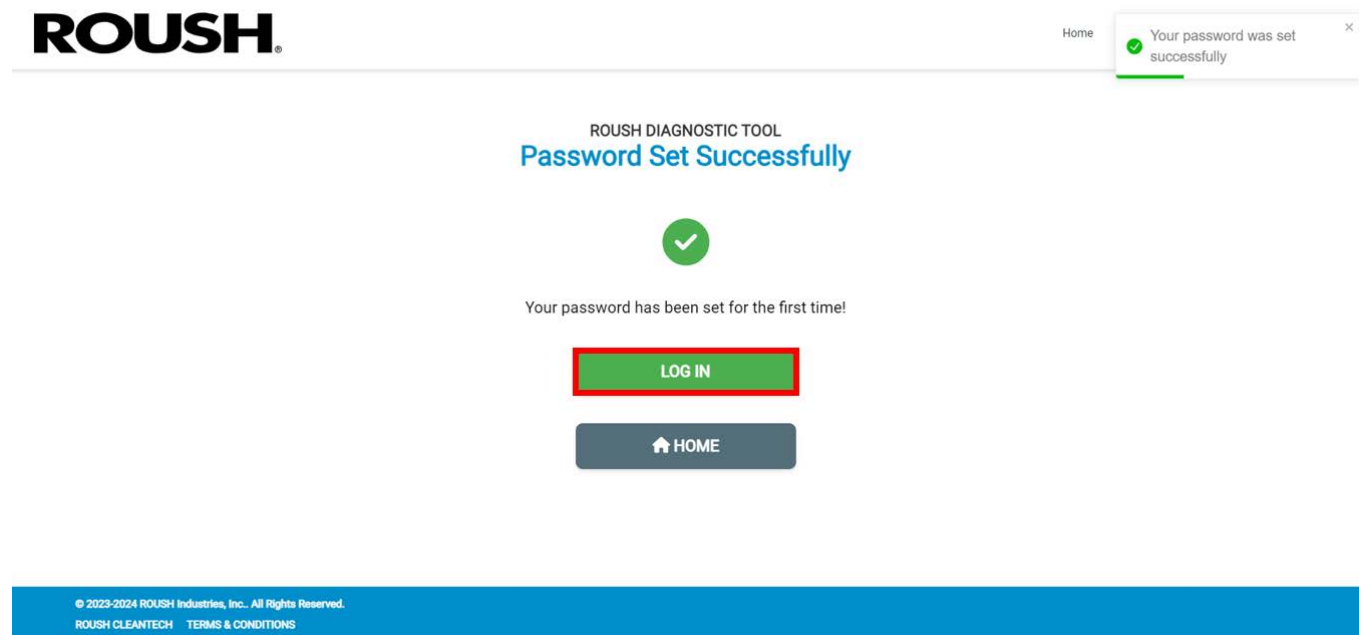

ROUSH DIAGNOSTIC TOOL

Password Set Successfully

✓

Your password has been set for the first time!

LOG IN

HOME

Home Your password was set successfully

© 2023-2024 ROUSH Industries, Inc. All Rights Reserved.
ROUSH CLEANTECH TERMS & CONDITIONS

7. Once the web page refreshes, click on “Log In”, enter your account email address” and password, then click on ”SIGN IN”.

ROUSH

Home Support LOG IN SIGN UP

ROUSH DIAGNOSTIC TOOL

Log In

CANCEL

SIGN IN

[Need an account?](#)

[Forgot your password?](#)

8. Once the web page refreshes, click on “DOWNLOAD RDT2 FOR ROUSH PERFORMANCE”.

Note: Please check RDT2 Desktop Tool Information on the bottom of the web page to make sure your laptop is supported by RDT2.

ROUSH DIAGNOSTIC TOOL

RDT2 User Portal

Welcome to the RDT User Portal

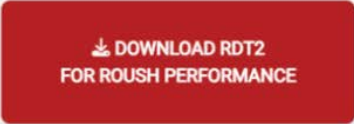

The more current release of RDT2 for Roush Performance is:
0.9.6



Use this if you need to reset your existing password or create a password for your new account.



If you need help using or obtaining RDT2, you can check the FAQ and get support here.

Step 8 continued: Verify to check if RDT2 supports your laptop type.

RDT2 Desktop Tool Information

RDT supports the use of RDT on the Windows 10 operating system on a computer with an open USB port. **Windows XP, 7, and Mac OS are not supported.**

Other requirements for RDT are as follows:

The following devices have been tested with RDT:

- EEPD MyCANIC or MyCANIC-FD
- Dearborn Group DPA5
- Ford VCM II or VCM 3
- Dashbridge CX – **NOT FOR USE BY RCT INSTALLERS**

Minimum Recommended PC Hardware Configuration:

- Processor minimum: 2.4 gigahertz (GHz) or greater Intel I5/I7 Dual Core
- Memory minimum: 4 gigabyte (GB) RAM or greater
- Windows 10
- Microsoft .NET Framework 4.0 or later

IMPORTANT: We require a reliable internet connection throughout the use of RDT on the vehicle.

© 2023-2024 ROUSH Industries, Inc.. All Rights Reserved.

ROUSH CLEANTECH TERMS & CONDITIONS

9. Open your downloads folder in your laptop, then double click on “RDTInstaller”.

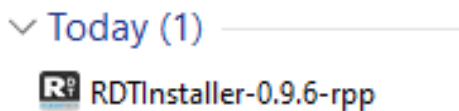

Step 9 continued: If your laptop is a PC, this window may pop up. Click on “More Info”, then click on “Run anyway” to open the RDT2 software.

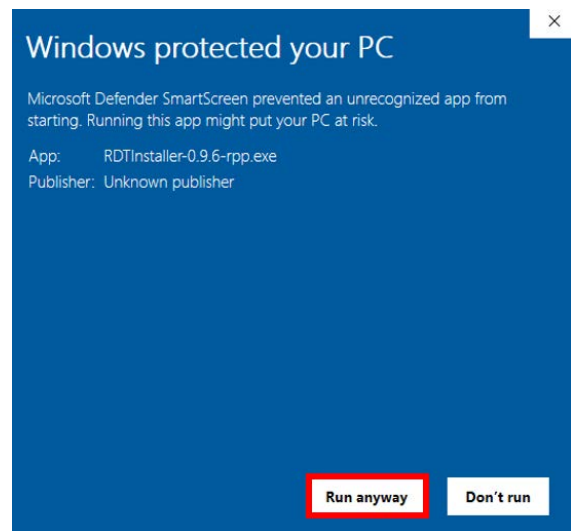
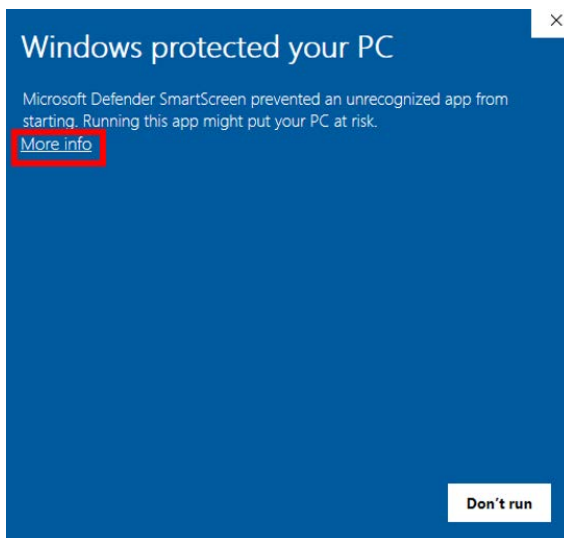

10. Download the RDT2 software to your laptop. Once the RDT2 software download is complete, click on the software icon on your desktop to open RDT2 software.



11. Once the software opens, click on “SIGN IN“.

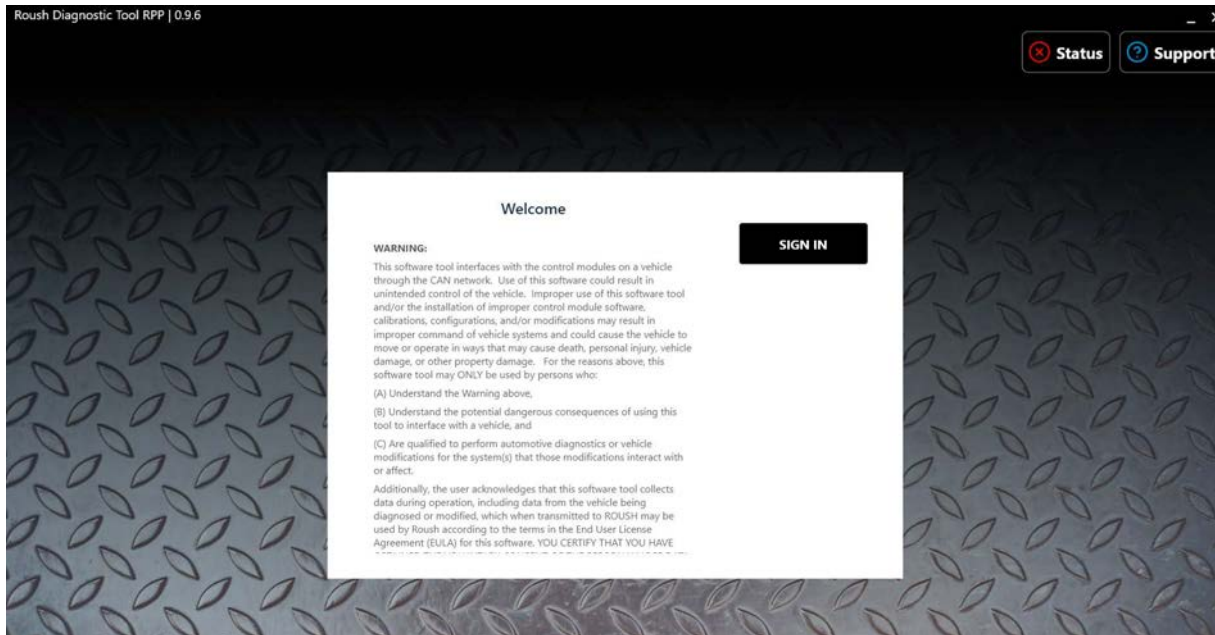

12. Once the software opens, click on “SIGN IN“.

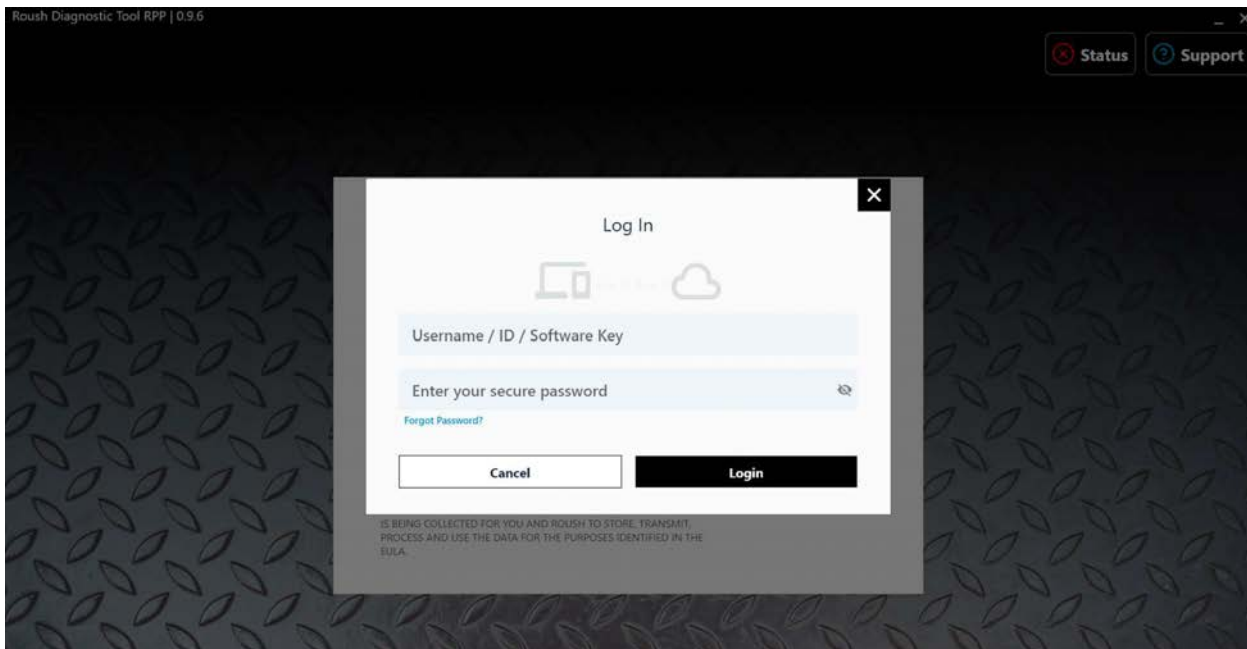

SECTION C – MODULE PROGRAMMING_VEHICLE FLASHING

The following pictured steps will guide you through the module programming - vehicle flashing process to install the new Roush vehicle calibration.

Note: RDT2 software requires an internet connection to flash the vehicle. Make sure all vehicle doors are closed BEFORE starting the flash process. Not doing so may result in a wrench light and a need to reflash the vehicle. If programming fails, flash vehicle back to factory using FDRS software and re-start vehicle flashing process.

1. Once RDT2 software opens, Connects your vehicle's OBD port to your laptop with the appropriate SAE J2534 vehicle communication device, using the Start/Stop button on your vehicle to power on the vehicle (Key On Mode). Click on "CONNECT DEVICE" to proceed.

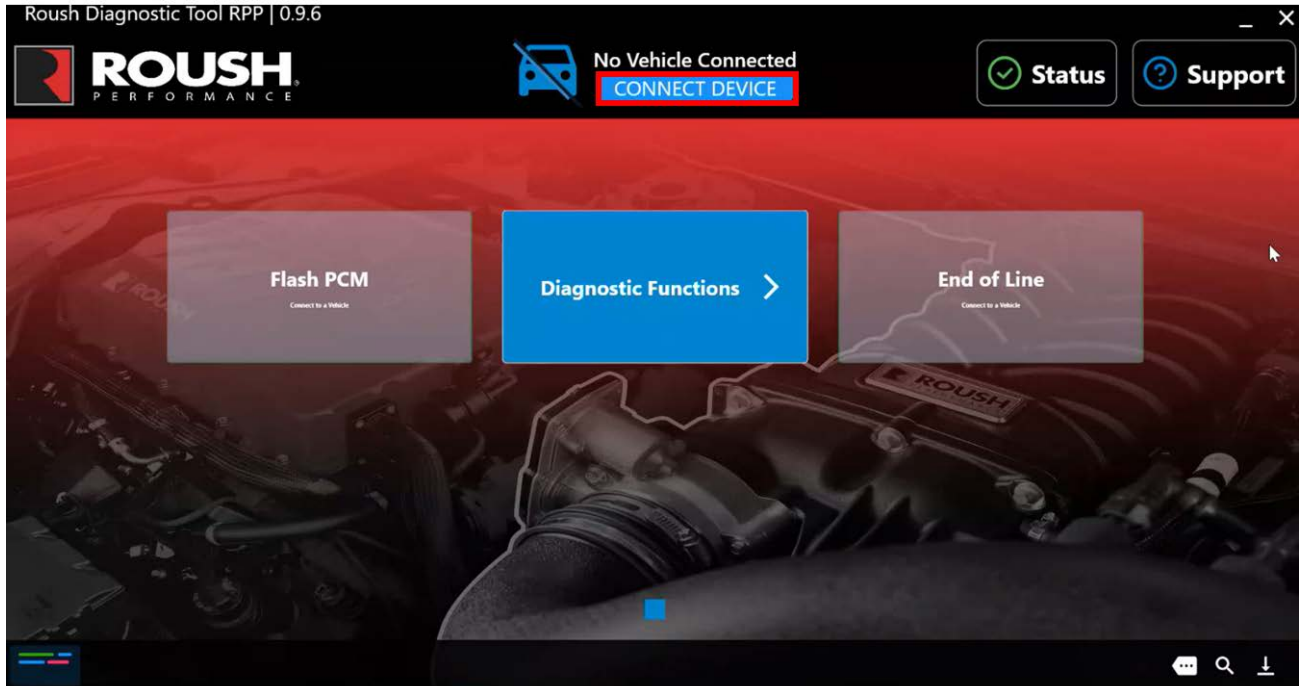

2. Once the software refreshes, choose your connect device from the drop down-list and click "Connect".

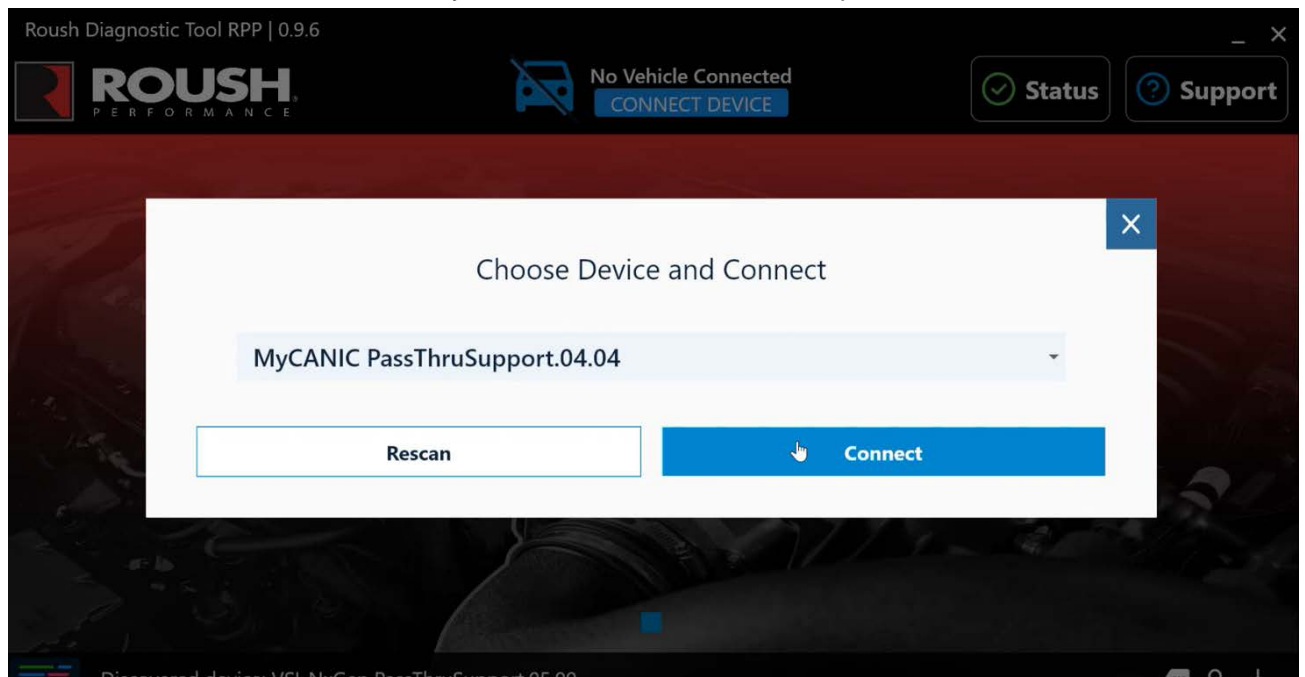

3. Once the web page refreshes, Verify your vehicle information, then click on “Proceed”

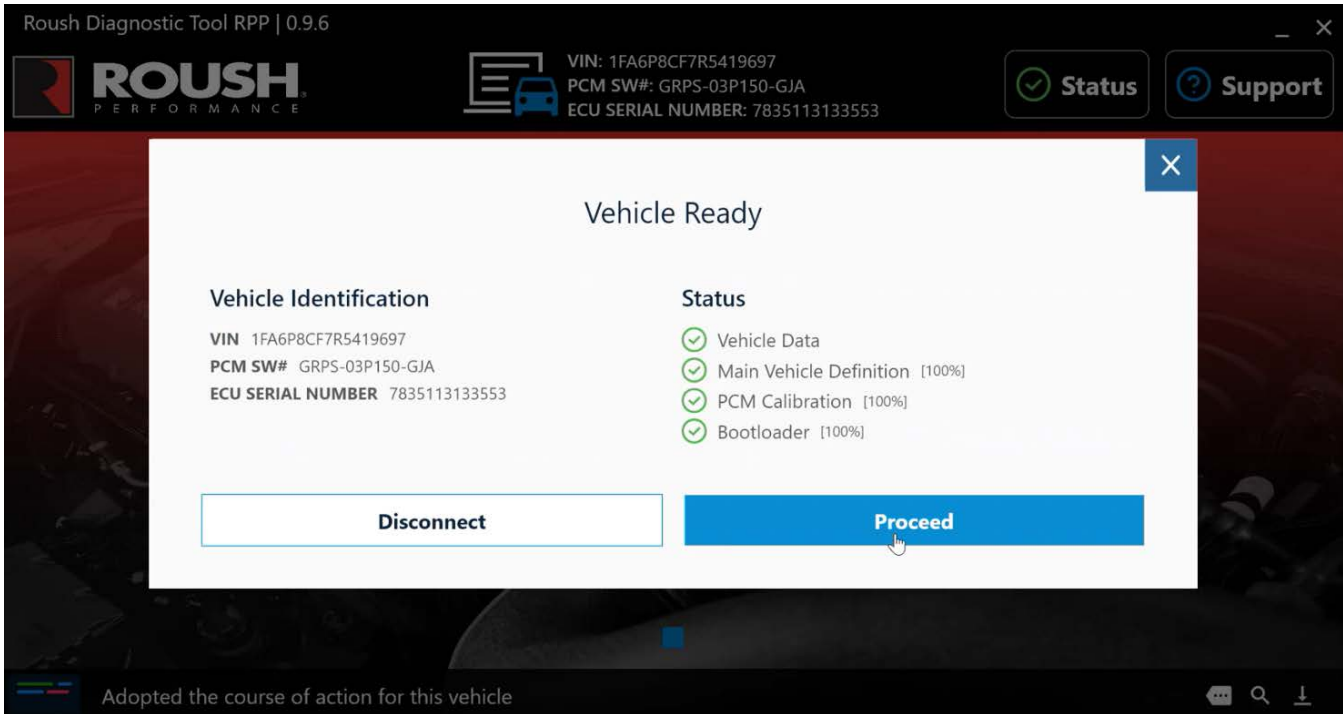

4. Once RDT2 software is connected to the vehicle, enter the Voucher Code and Voucher Family using your Voucher card. (Item 52, page 9) then click “Submit”. **NOTE: THE VOUCHER CODE AND VOUCHER FAMILY ARE BOTH CASE SENSITIVE.**

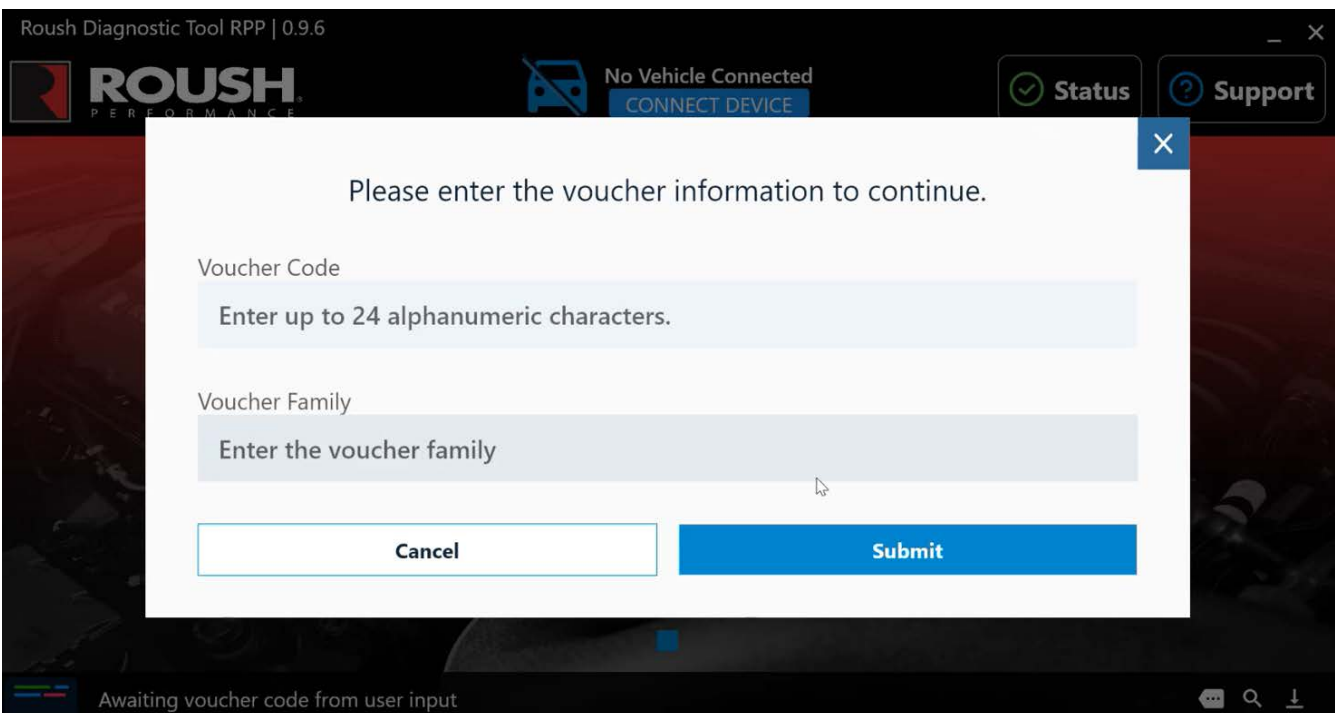

5. Once the software refreshes, click on “Flash PCM”.

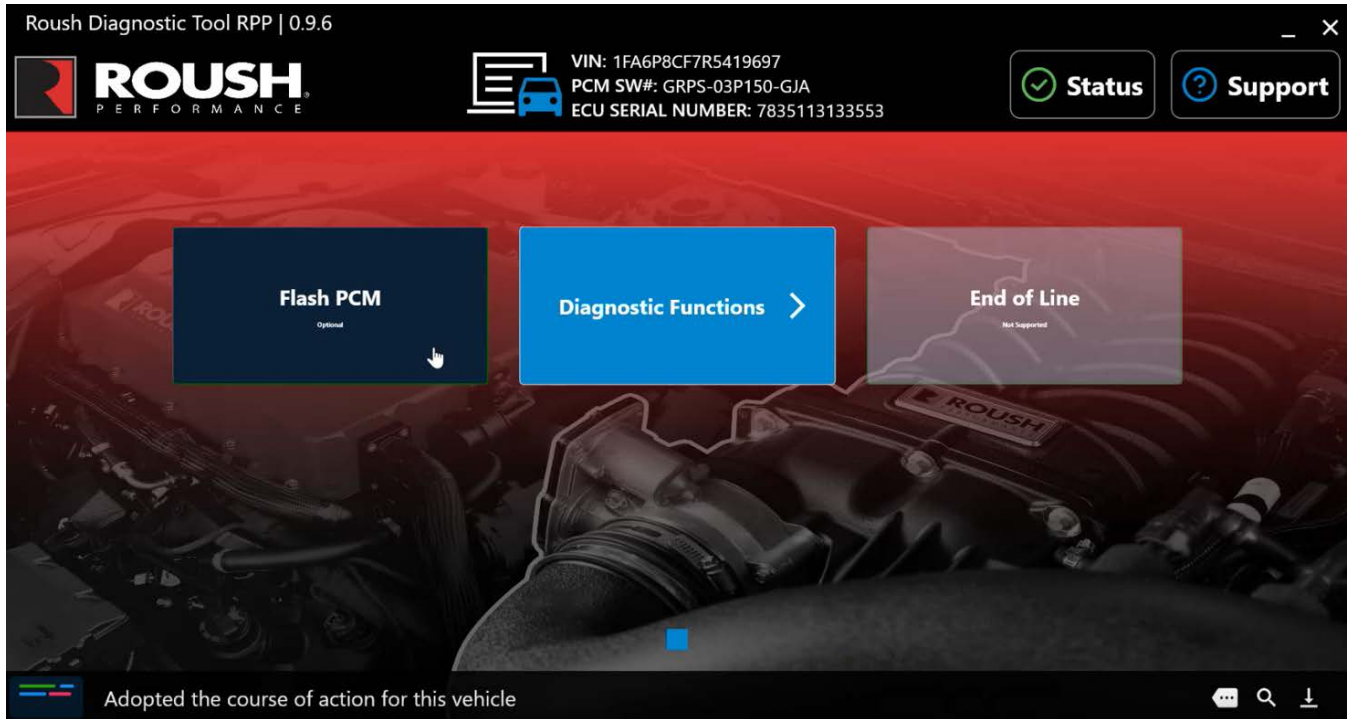

6. Once the web page refreshes, Verify your vehicle information, then click on “Proceed”

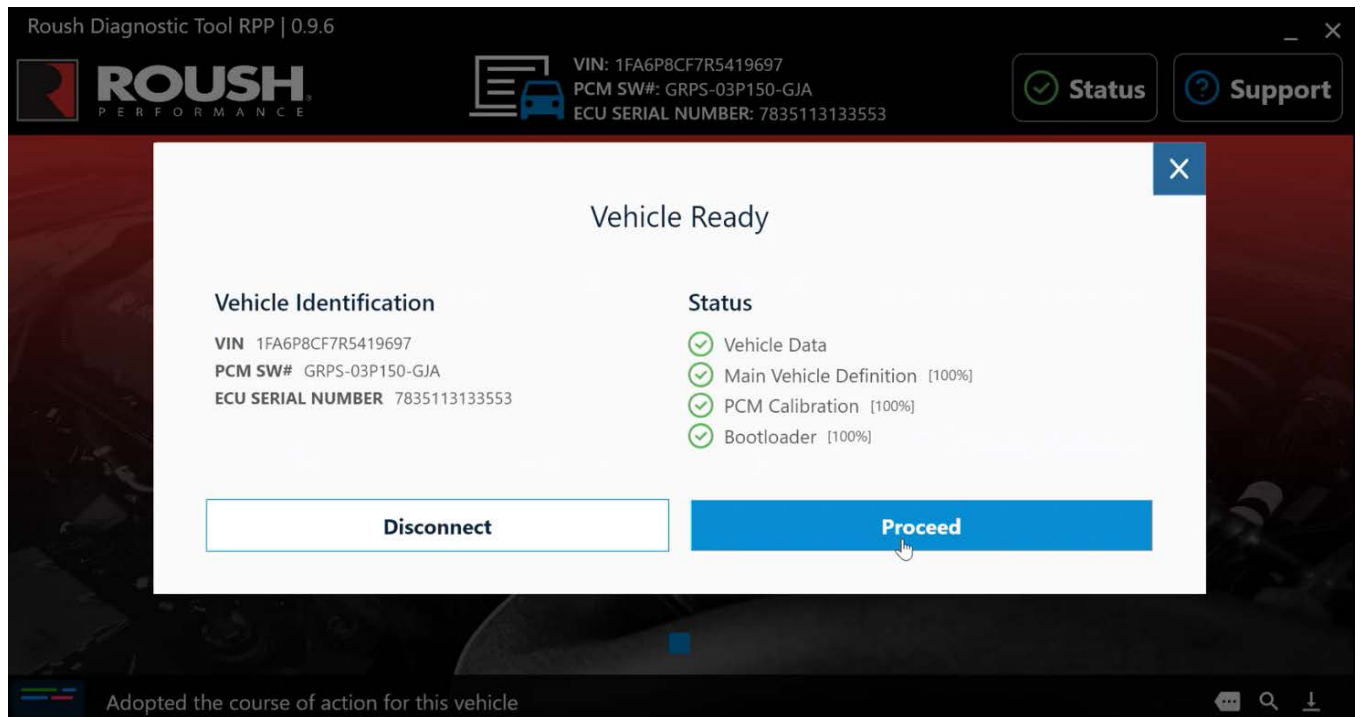

7. Once the software refreshes, click on “Flash PCM”.

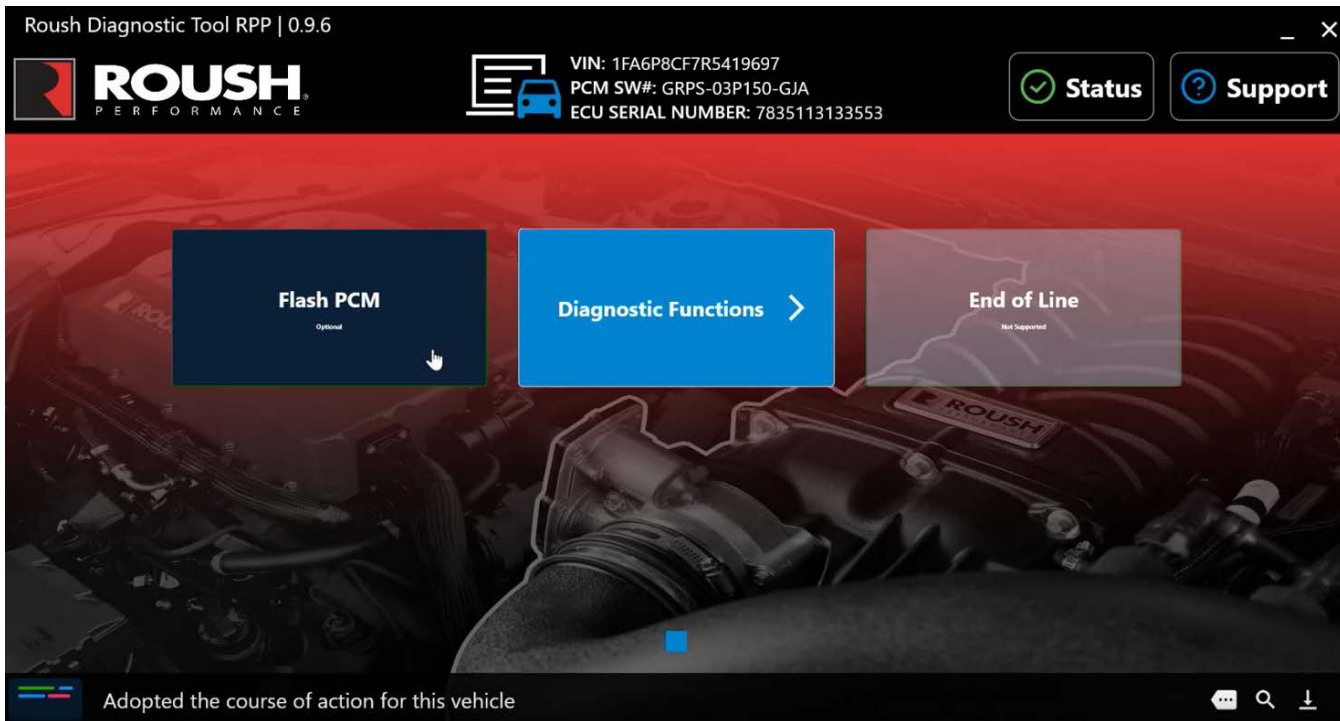

8. Once the software refreshes, verify your vehicle information, click on “NEXT”.

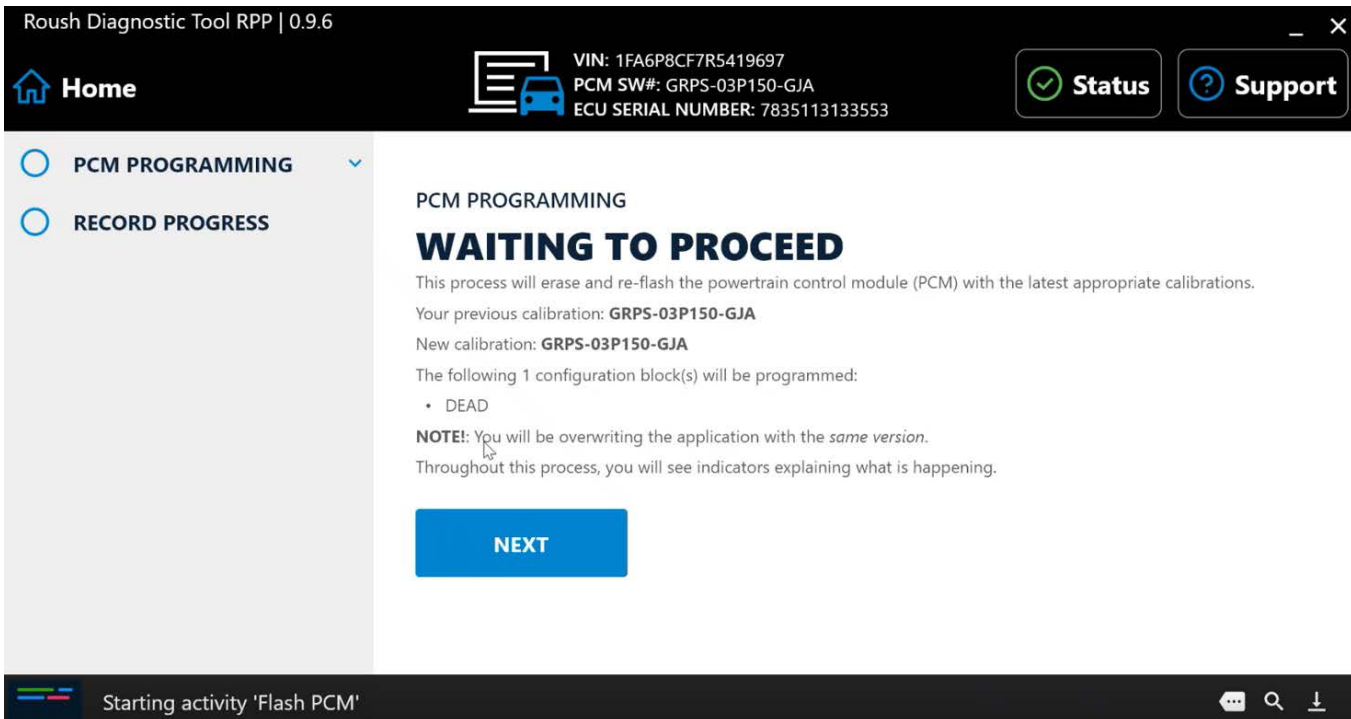

9. Once the software refreshes, click on "BEGIN".

Roush Diagnostic Tool RPP | 0.9.6

VIN: 1FA6P8CF7R5419697
PCM SW#: GRPS-03P150-GJA
ECU SERIAL NUMBER: 7835113133553

Home Status Support

PCM PROGRAMMING

RECORD PROGRESS

WAITING: PCM PROGRAMMING

This procedure will update or replace the application and calibrations programmed into the Powertrain Control Module (PCM).

The programming process will begin now. As a reminder, during this process:

1. Do not turn off the vehicle
2. Do not touch any vehicle controls
3. Do not disconnect your J2534 device

BEGIN

Starting activity 'Flash PCM'

10. Once the software refreshes, the PCM Programming will begin as shown. **MAKE SURE YOUR LAPTOP IS STILL CONNECTED TO THE INTERNET!**

Roush Diagnostic Tool RPP | 0.9.6

VIN: 1FA6P8CF7R5419697
PCM SW#: GRPS-03P150-GJA
ECU SERIAL NUMBER: 7835113133553

Home Status Support

PCM PROGRAMMING

Erased PCM

Wait Before Programming

Program PCM

Validate Application

Prompt Flash Failure

Reset Module

Wait for Prog Diag Mode

Reenter Prog Diag Mode

Reset Programming Security

Test DEAD Write

Write DEAD

Reset Module Again

Wait for Exit Diagnostic Mode

RUNNING: PROGRAM PCM

3 %

The current operation has entered a new state: 'Program PCM'

11. Once the PCM Programming is completed at 100%, the “RUNNING: PROMPT CYCLE POWER” page will appear as shown. Follow the instructions by using the Start/Stop button on your vehicle to turn off the vehicle, wait for 15 seconds, and power on the vehicle (Key On Mode). Click “OK” to proceed.

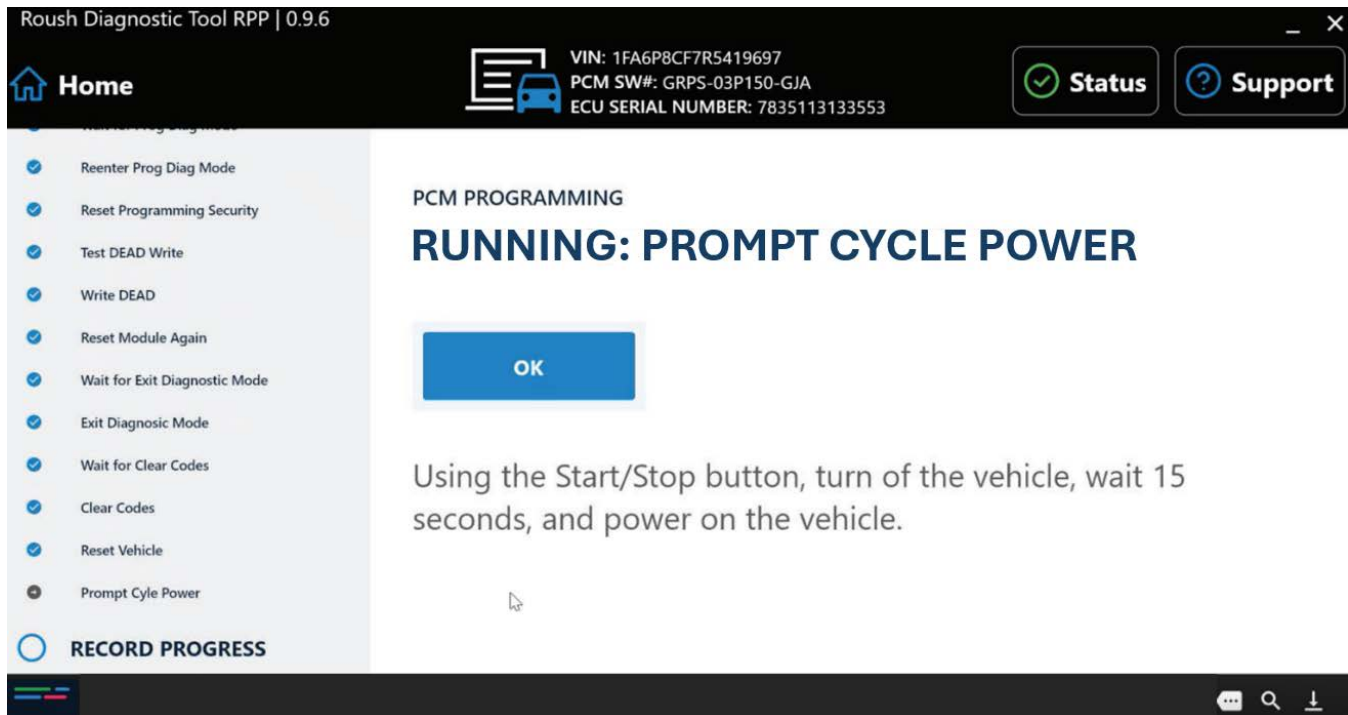

12. Congratulations! Your vehicle is now equipped with the latest ROUSH calibration.

MAKE SURE TO REGISTER YOUR ROUSH SUPERCHARGER KIT BY GOING TO: <https://support.roushperformance.com/s/article/ROUSH-Performance-Warranty-Information>.

Adaptive Learning Drive Cycle For Automatic Transmission

IT IS NORMAL TO HAVE HARSH/ROUGH SHIFTS AFTER INSTALLATION IS COMPLETE. FOLLOW THE BELOW PROCEDURES TO SPEED UP THE VEHICLE TRANSMISSION LEARNING TIME.

Programming Procedures

NOTE: Perform the adaptive learning drive cycle on a level road surface.

1. **NOTE:** Vehicles equipped with diesel engines use a TCM (transmission control module) that stores the transmission strategy information. Using the scan tool, clear the TCM KAM .
2. Using the scan tool, clear the DTCs (Diagnostic Trouble Codes) and Transmission Adaptive Tables.
3. Drive the vehicle until the engine and transmission reach normal operating temperature.
4. Accelerate from a stop with light throttle (15%) ensuring that upshifts 1st through 8th occur at engine speeds between 1300-1600 rpm.
5. Continue to accelerate (may apply slightly more throttle after 7-8 upshift at 32-38 mph (51-61 km/h) until you achieve 55 mph (88 km/h) and the 8-9 and 9-10 shifts complete.
6. Brake very gently to a complete stop and hold foot on brake for five (5) seconds.
7. Shift the transmission to Neutral. Wait 1 second.
8. Shift the transmission to Reverse. Wait 2 seconds.
9. Shift the transmission to Neutral. Wait 1 second.
10. Shift the transmission to Drive. Wait 2 seconds.
11. Repeat Steps 3 through 9 six additional times.

Note: Refer the above information to Ford Motorcraft website.

LTR BOTTOM MOUNT - DRILL TEMPLATE

NOTE: PLEASE PRINT ACTUAL SIZE!

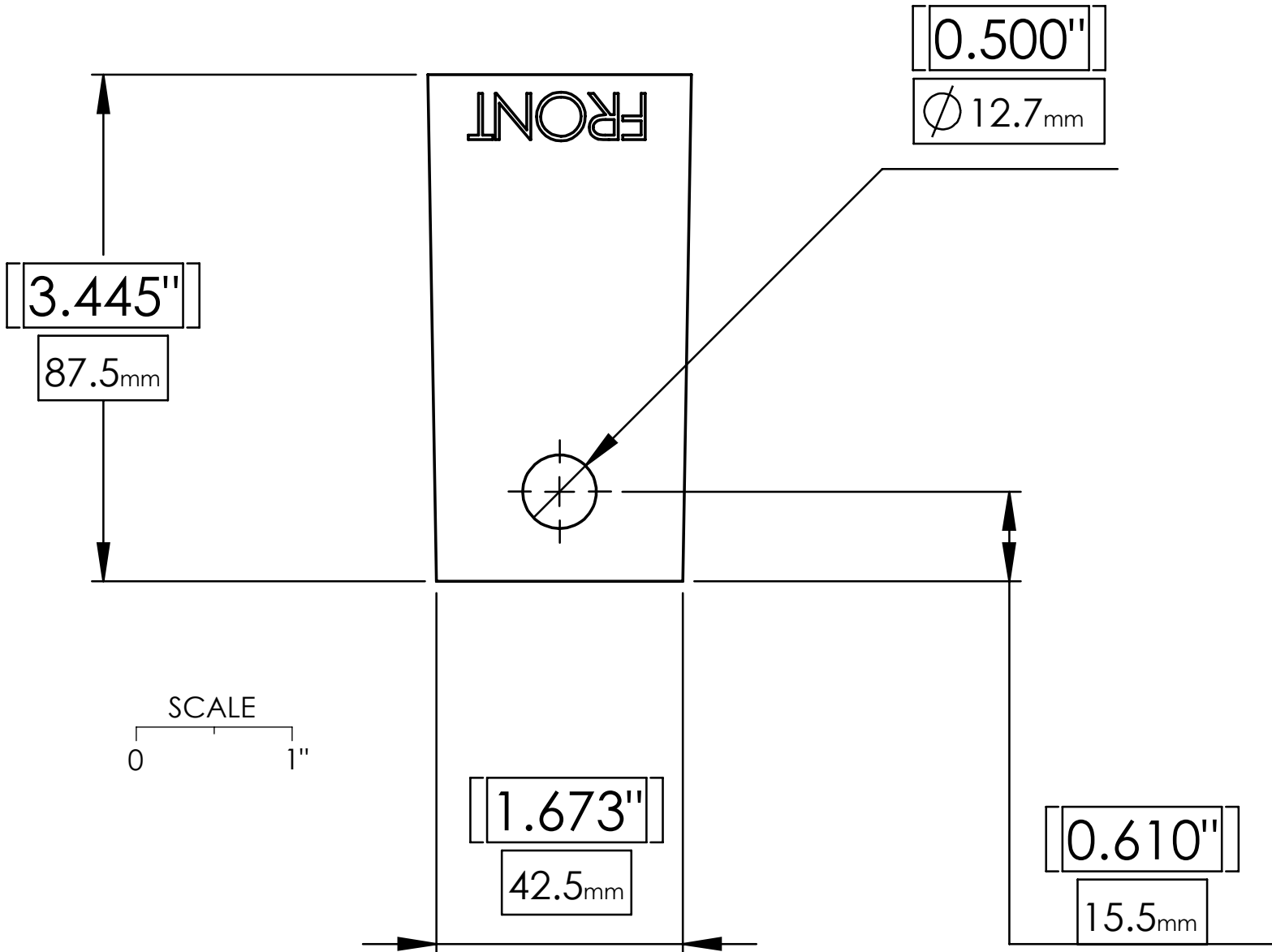

DEGAS BOTTLE - DRILL TEMPLATE

NOTE: PLEASE PRINT ACTUAL SIZE!

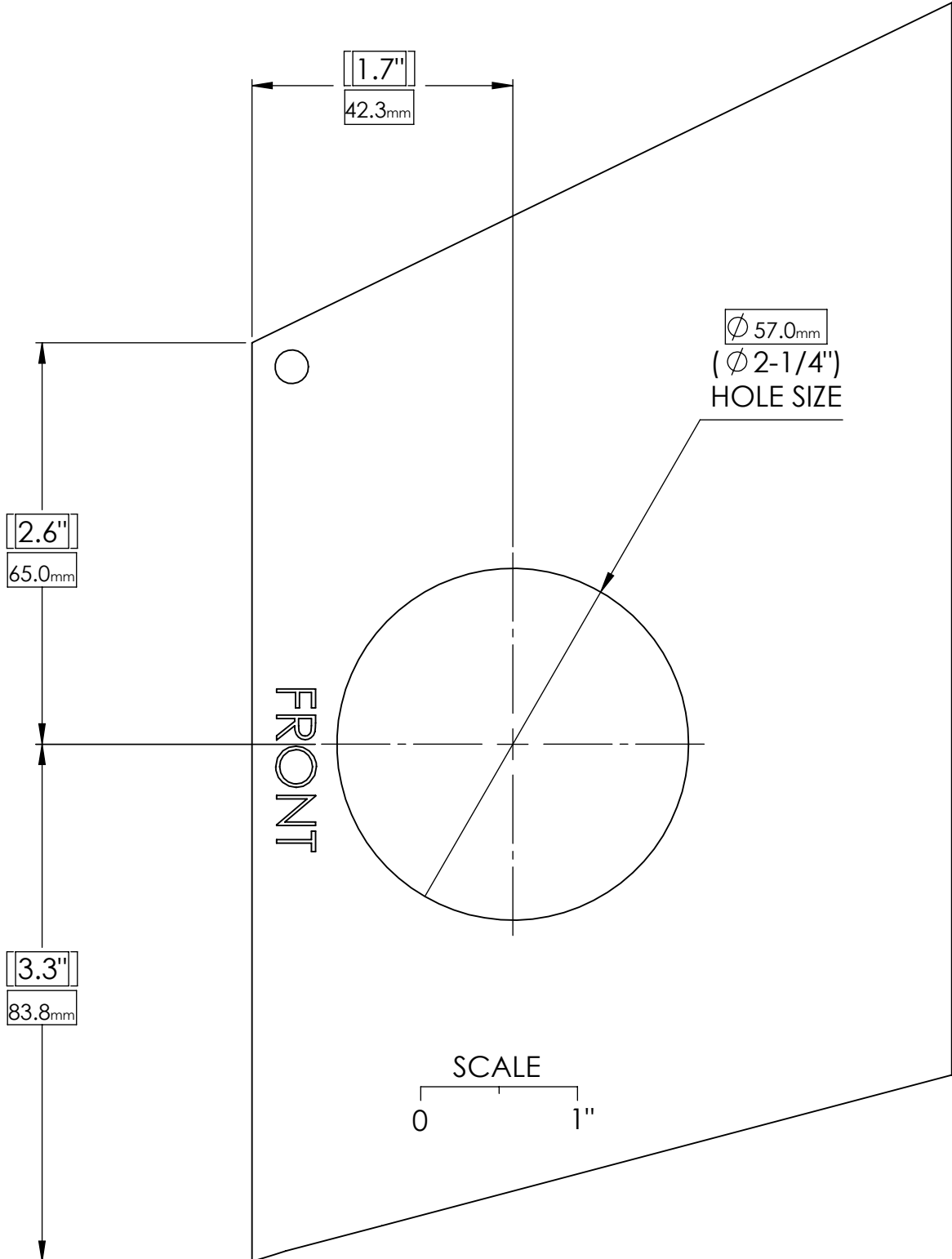

BELT ROUTING DIAGRAM

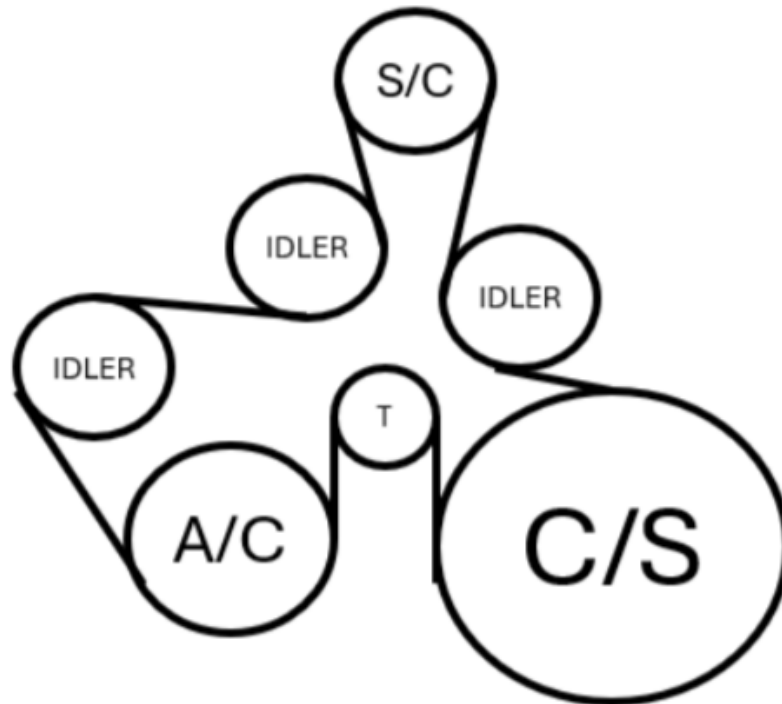

SUPERCHARGER BELT ROUTING DIAGRAM

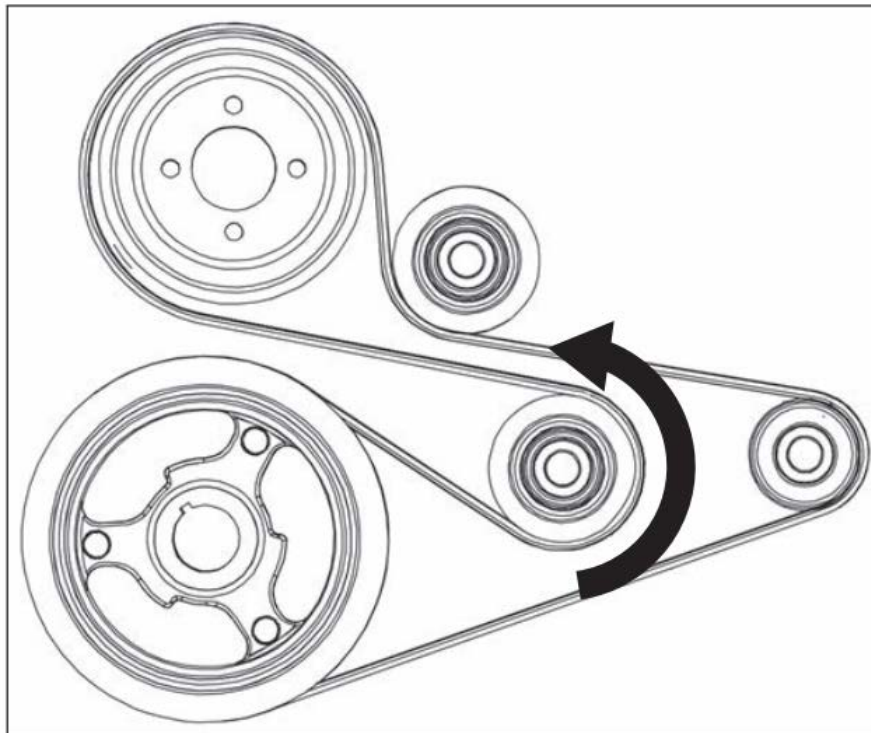

FACTORY FEAD BELT ROUTING DIAGRAM