

# 2018-2021 5.0L MUSTANG PHASE 1 & 2 ROUSHCHARGER KIT

## INSTALLATION INSTRUCTIONS

P/N: 422090/422184

R1318-6006P1&2

EO: D-418-41



**ROUSH**<sup>®</sup>  
P E R F O R M A N C E

28200 Plymouth Rd, Livonia, MI 48150 | 800.59.ROUSH

# 2018-2021 5.0L Mustang Phase 1 & 2 ROUSHcharger Kit Installation Instructions

P/N: 422090/422184 (R1318-6006P1&2)

EO: D-418-41



**Application: 2018+ Ford Mustang GT with 5.0L 4-Valve Engine (Kit does not fit Bullitt Mustangs)**

### Important Notes:

- Before installing your Mustang ROUSHcharger Kit, please read the installation manual and verify that all items are present. If you are missing hardware or have any questions, please contact ROUSH Performance at 1-(800) 59-ROUSH.
- Premium fuel (91 octane or higher) is required to prevent "spark-knock" or detonation under certain operating conditions.
- The use of fuel additives (i.e. octane boosters) is not recommended. There is a possibility that these chemicals can damage your engine and cause drivability issues with your vehicle.
- Operating your engine without the ROUSH PCM recalibration will result in engine damage or failure and will void your warranty.
- **5W50 SN PLUS OR SP FULL SYNTHETIC OIL IS REQUIRED** to be used. Change engine oil at time of supercharger kit installation.

**Table of Contents**

Packing List For R1318-6006P1 ROUSHcharger Kit .....3

Equipment and Supplies Required.....6

Glossary of Terms .....6

Information About the Supercharger Bypass Operation .....7

Important Information Regarding Supercharger Noise.....7

Limit of Liability Statement .....7

Safety Precautions.....7

Section A – Disassembly.....8

Section B – Modifications .....21

Brake Booster Vacuum and Aspirator Hose Assembly Modification .....21

Evaporative Emissions Canister Purge Line .....23

Electric Fan Shroud Modification .....23

Front Cover Modification .....24

Intercooler Pump Harness Procedure.....26

MAF-to-MAP Harness.....27

Changing the Factory Spark Plugs .....31

Section C – Subassembly .....34

Intercooler Low Temperature Radiator (LTR) .....34

Reservoir Bottle Preparation .....35

Intake Manifold Buildup .....36

Supercharger Buildup.....36

Fuel Rail Assembly.....37

Airbox Assembly.....39

Intercooler Hard Line Assembly .....40

Crankshaft Pulley Replacement.....40

Section D – Installation.....42

Induction Resonance Tube Delete Grommet .....42

Intake Manifold and Fuel Rails.....42

Upper FEAD Bracket.....45

Supercharger.....46

Heater Core Lines and Coil Cover Brackets .....49

PCV Purge Hose .....50

Lower FEAD Assembly .....51

Intercooler Low Temperature Radiator (LTR) Assembly .....53

Intercooler Reservoir Bottle.....55

Intercooler Pump And Hoses .....55

Air Box Assembly/Air Induction System.....63

Disassembly .....66

Installation .....67

Front Fascia Removal.....69

Section E – Final Assembly.....73

PCM Flashing .....73

Cooling Fan Shroud Modification Template .....74

Appendix A Hydrocarbon Trap Relocation .....76

Appendix B MODULE PROGRAMMING.....77

Appendix C End of Line .....80



PACKING LIST FOR R1318-6006P2 ROUSHCHARGER KIT

Description	Part Number	Quantity
<b>Air Induction</b>		
Upper Airbox Cover	1318-9643	1
MAP Tube	131537-12B579	1
Lower Airbox Tray	131550-9A612	1
Dirty Air Duct	1315-9F763	1
Tube Assembly - Clean Air	1318-9B659	1
Air Filter - Dry	131550-9601R	1
AIS Hardware Kit	1318-TVSHWKA	1
Hose Clamp	R07130015-13	2
Screw, Self Tapping M6x25 mm	W506976-S437	6
Push Nut- ROUND NO. 6 (Hydrocarbon Trap Retention)	94800A705	4
Bolt M8x1.25x25 (MAF Tube-to-Airbox)	W500224-S437	2
Grommet (Boom Tube Delete)	W651016	1
<b>Intake Manifold Hardware</b>		
Manf Assembly - Fuel Charging	1318-9H487	1
Supercharger Assembly - Less Pulley (FIFD 2650)	1318-6F066	1
Intake Components	1318-KIT2	1
Fuel Rail Assembly	1318-9F792	1
S/C Pulley - 6K Grooved - 80 mm (may be installed on Supercharger)	1318-6K80	1
Throttle Body - 87 mm Single Bore (KR3Z-9E926-A)	M-9926-M50BRSH	1
Fuel Injector Kit (Set of 8)	13119F593K	1
Spark Plug (Pack of 8)	M-12405-M50A	1
Intake Hardware Kit	1318-TVSHWKB	1
Gasket - T-Body (Dash 241 Viton O-Ring)	1318-9E936	1
Bolt - Intake-to-Cylinder Head	R18020004-00-S439	6
Bolt - S/C-to-Intake Manf Upr	161826	8
M8x1.25x35 Pan Head Bolt - Knock Sensor	92095A292	4
Bolt M6x1.0x45 Fuel Rail-to-Cylinder Head	161817	5
Bolt - Fuel Rail-to-Intake Manifold - (M6x1.0x20 mm)	BM6X100X20HF-S437	5
Pressure Sensor - Supercharger Inlet	CV2Z-9F479-A	1
Bolt - M6x1x24 (SIP-to-Front Cover)	N807309-S437	1
<b>FEAD</b>		
FEAD Components	1318-KIT3	1
FEAD Bracket - Upper	1318-8B653U	1
FEAD Tensioner Bracket Assembly	1318-8B653	1
Serpentine FEAD Belt - 1st Sheave 6K	K060806	1
FEAD Hardware Kit	1318-TVSHWKC	1
Pulley - 6K Grooved Idler - 77 mm	900162	1
Pulley - Idler Smooth 70 mm	FS00060235	2



Description	Part Number	Quantity
Idler Pulley Post	1318-8B653P	1
Bolt - M8x1.25x70 Flange Bolt	11116112	1
Bolt - Upper FEAD-to-Intake (M8x50)	W500313-S437	1
Bolt - Idler (M8x1.25x28_large washer) (N808102)	R18020060-00	2
Bolt - Upper Bracket-to-Engine (M8x1.25x60)	11116346	4
Bolt - Lower Bracket-to-Engine (M8x1.25x120)	N811329-S437	2
2018 5.0L Crank Damper	FS00055089	1
Bolt - Crank Damper	BR3Z-6A340-A	1
<b>PCV, Vacuum and Cooling</b>		
PCV Components	1318-KIT4	1
PCV Fresh Air Inlet	1318-6758	1
Hose Aspirator to SC	1318-9D692	1
Water Pump	1318-8501	1
PCV Purge Hose with Bubbler - Valve-to-Spacer	1318-6K817	1
Bevis Extension Hose	1318-9G272	1
Hose - Aspirator-to-Clean Air Tube	1318-9D691	1
Hose - Aspirator-to-Brake Booster	1315-9D690	1
Intercooler Hard Line Assembly	1318-8D028	1
3/4" Hose Assembly-CAC-to-Degas Bottle	1318-8D029	1
3/4" Hose Assembly - LTR-to-CAC	1318-8D030	1
3/4" Hose Assembly - Pump-to-LTR	1318-8K236	1
3/8" Hose Assembly - Engine Bottle Degas Hose	1318-8276	1
Degas Bottle	1318-8D080	1
Reservoir - Intercooler System	1318-8D081	1
PCV Hardware Kit	1318-TVSHWKD	1
Clamps - 5/8" Hoses (Constant Tension)	7329K11	3
Cap, 3/8 VMV Outlet Vacuum	CS2575	1
Vacuum Harness - S/C Bypass Reference	1318-9E498	1
<b>Wiring</b>		
Wiring Hardware Kit	1318-TVSHWKE	1
MAF Connector Plug	1318-MAFPLG	1
Electrical Jumper - I/C Pump	1320-8W501	1
MAF to MAP	1318-12B579W	1
LTR Water Temperature Sensor	1320-12B579S	1
LTR Water Temperature Harness	1320-12B579WJ	1
Nut - I/C Relay Mounting (M6x1.0)	W520412-S437	1
Pack of Zip Ties (25)	ZIP-TIE-KIT	1
<b>Emblem/Covers/Decals/Labels/Instructions</b>		
Paperwork Hardware Kit	1318-TVSHWKG	1
Supercharger Badge	1318-6F066BDG	1

Description	Part Number	Quantity
RDT Voucher Card	P1318-P1	1
Decal - Premium Fuel Only (Fuel Door)	13109A095	1
Decal - 2018 Belt Routing and Vacuum	1318-6E072	1
Decal - PCM	R07100008-10	1
Sticker 5W-50	1318-5W50ST	1
EO Label – 18+ Mustang and F150SC	D41833-9A095EO	1
Label - Spark Plug Warning	PT00045644	2
<b>Intercooler System - Miscellaneous</b>		
Low Temperature Radiator Assembly	1318-8K229	1
Bar Spanner LTR Mount	1318-8K241	1
Bracket Components	1318-KIT1	1
Bracket - Coil Cover LH	1318-6P069	1
Bracket - Coil Cover RH	1318-6P070	1
Bracket - Upper LTR Mounting (LH)	1318-8K242	1
Bracket - Upper LTR Mounting (RH)	1318-8K243	1
Bracket - LTR Lower	1318-8K244	2
I/C Pump Bracket	1318-8C4191	1
Cooling Hardware Kit	1318-TVSHWKH	1
3/4" Hose Assembly - RSRV-to-Pump	1318-8D027	1
3/4" Hose Assembly Jumper	1318-8D032	2
LTR Foam Seal	1318-8K230	1
Foam - Water Pump/Reservoir Mounting	1318-8D082	7
Degas Bottle Cap	9C3Z-8101-B	1
P-Clip	8863T95	1
Bracket - Intercooler Reservoir	1318-8C4192	2
5/16 Flat Washer extra thick 18-8 Stainless Steel	11103759	4
Rubber Grommet - LTR Isolator	R07060107-13	6
Sleeve - LTR Isolator	R07060108-13	6
Bolt - LTR (M8x1.25x25)	W500224-S437	8
Bolt - Degas Bottle-to-Fan Shroud (M6x1.00x16)	N605891-S437	2
Nut - LTR to Radiator Support (M8)	W520413-S437	4
Bolt - M8x1.25x16 Flange	161821	7
<b>Bolt - M6x1x24 Spanner Bracket-to-Chassis</b>	N807309-S437	4
Degas Bottle-to-Fan Shroud Retaining Clip	20860	1
Clamps - 3/4" Hoses (Constant Tension)	CT19X12-BO	7
Bolt - P-Clip to Bracket	BCSM-08016S	1
J-Clip - Degas Bottle (M6 Short)	N623332-S439	6
Sleeve, 424 mm 3/4" hose	1311-18K579SLV	2
Fuel Pump Voltage Regulator (New kits contain this in the calibration)	1315-FPVRKIT	1

If you are missing any items, please call us toll free at 1-800-59-ROUSH.

## EQUIPMENT AND SUPPLIES REQUIRED

- 1/4" and 3/8" Drive Ratchets with Extensions
- Metric and Standard Socket Sets (short and deep recommended)
- Metric and Standard Wrench Sets
- 3/8" Drive Torque Wrench (7-35 ft-lb range)
- 6" Scale, Tape Measure, or Other Measuring Device
- Assembly Lubricant (White Lithium Grease or Petroleum Jelly)
- Electrical Tape
- Sharp Knife or Razor Blade
- Medium Strength Thread Locker – Loctite® 242 (blue) or equivalent
- T-20 Torx Bit Screwdriver or Socket
- 5/16" Drill Bits and Drill motor
- Coolant (meeting Factory Ford specification for 2018 Mustang GT)
- 1/2" Drive Ratchet or Breaker Bar
- Short Phillips-head Screwdriver
- 3/8" Fuel Line Removal Tool
- Heat Gun or Small Torch for Heat Shrink Tubing
- Trim Pad Tool (for pushpin removal)
- Fender Cover (2)
- 6.9 mm (17/64) Drill Bit
- M8x1.25 Tap
- Heat Gun

## GLOSSARY OF TERMS

Air Charge Temperature (ACT) Sensor (From the factory, this function is integrated into the MAF sensor. With this kit, a separate ACT sensor is installed into the intake manifold)

Electronic Throttle Control (ETC)

Mass Air Flow (MAF) Sensor

Manifold Absolute Sensor (MAP)

Powertrain Control Module (a.k.a. ECM, ECU, PCU, EEC)

Positive Crankcase Ventilation (PCV)

Supercharger Inlet Pressure (SIP)

Throttle Position Sensor (TPS)

ROUSH Diagnostic Tool (RDT)

Vapor Management Valve, or Evaporative Emissions Canister Purge Valve (EECPV)

Breakout Point – A place in an electrical harness where the wiring for an individual component leaves (breaks out of) the main harness to attach to an individual component.



## INFORMATION ABOUT THE SUPERCHARGER BYPASS OPERATION

There is a great deal of misinformation about the function of supercharger bypass systems. The supercharger is a positive-displacement pump; that is, so long as it is rotating, it is always pumping air. During low demand or high vacuum operation (i.e. idle, deceleration, and light throttle cruise), the pumping action is undesirable as it creates unwanted heat and noise. The bypass circuit, when open, prevents any pressure buildup across the supercharger and allows air to circulate through the rotors, allowing the supercharger to "idle" freely during these conditions. This results in reduced noise, and by reducing heat buildup in the intake, significantly improves street and strip performance. As throttle demand increases, the bypass circuit is closed, resulting in full performance from the supercharger. The bypass circuit is never used to limit or control boost during full-throttle operation and defeating or altering the bypass function will not result in improved performance in any condition, and will result in poor drivability.

## IMPORTANT INFORMATION REGARDING SUPERCHARGER NOISE

We understand that you may notice some noise variations from your supercharger. The majority of noises are completely normal and each supercharger can have a different noise signature. As superchargers are belt-driven by the engine, the engine's torsional vibrations will cause the mechanical components of the supercharger, including gears, shafts, and bearings, to make noise. Noise levels can also be influenced by both the supercharger and ambient air temperatures, especially in cold environments. As temperatures and engine speeds vary, the characteristics of the noise may change. It's important to note that each unit may produce slightly different sounds due to these variables. Generally speaking, these noises do not affect the performance, reliability, or longevity of your supercharger and are not cause for concern. If you have any concerns, please feel free to reach out to our team.

## LIMIT OF LIABILITY STATEMENT

The information contained in this publication was accurate and in effect at the time the publication was approved for printing and is subject to change without notice or liability. ROUSH Performance Products reserves the right to revise the information presented herein or to discontinue the production of parts described at any time.

## SAFETY PRECAUTIONS



## CAREFULLY READ THE IMPORTANT SAFETY PRECAUTIONS and WARNINGS BEFORE PROCEEDING WITH THE INSTALLATION!

Appropriate disassembly, assembly methods and procedures are essential to ensure the personal safety of the individual performing the kit installation. Improper installation due to the failure to correctly follow these instructions could cause personal injury or death. Read each step of the installation manual carefully before starting the installation.

- Always wear safety glasses for eye protection.
- Place the ignition switch in the OFF position.
- Always apply the parking brake when working on the vehicle.
- Block the front and rear tire surfaces to prevent unexpected vehicle movement.
- Operate the engine only in well-ventilated areas to avoid exposure to carbon monoxide.
- Do not smoke or use flammable items near or around the fuel system.
- Use chemicals and cleaners only in well-ventilated areas.
- Batteries can produce explosive hydrogen gas which can cause personal injury. Do not allow flames, sparks or flammable sources to come near the battery.
- Keep hands and any other objects away from the radiator fan blades.
- Keep yourself and your clothing away from moving parts when the engine is running.
- Do not wear loose clothing or jewelry that can be caught in rotating or moving parts.

## SECTION A – DISASSEMBLY

The following section will guide you through the disassembly of the stock components. Special care should be taken to label fasteners and parts that are taken off during this procedure since many will be reused:

1. Cover both fenders with fender covers to protect the vehicle finish.
2. Release the fuel system pressure.

**NOTE:** The following procedure is taken directly from the Ford Service Manual).

### **WARNING**

**Fuel in the fuel system remains under high pressure even when the engine is not running. Before working on or disconnecting any of the fuel lines or fuel system components, the fuel system pressure must be relieved. Failure to do so can result in personal injury.**

### **WARNING**

**Do not smoke or carry lighted tobacco or open flame of any type when working on or near any fuel-related components. Highly flammable mixtures are always present and can be ignited, resulting in personal injury.**

- a. Locate the under hood fuse panel.
  - b. Remove the fuse for the fuel pump (fuse number 48 or 49).
  - c. Start the engine and allow it to idle until it stalls.
  - d. After the engine stalls, crank the engine for approximately 10 seconds to make sure the fuel injector supply manifold pressure has been released.
  - e. Turn the ignition switch to the OFF position.
3. Open the hood. Remove the push pins from the battery cover panel located on the passenger side of the engine bay, and remove the panel.



4. Loosen the retaining nuts and disconnect the (-) negative and (+) positive connections to the battery. Stow the cables out of the way.



5. Remove the nineteen (19) lower close-out panel bolts and the six (6) push pins. Remove the lower close-out panel from the vehicle (7 mm socket).





6. With the engine cool, remove the cap on the engine coolant degas bottle and drain the coolant using the petcock located on the lower passenger side of the radiator. Save the coolant for reuse.

**Tip:** Connect a 3/8" hose to the drain fitting next to the petcock and run into a clean drain pan or bottle. Use a 3/4" wrench to open petcock and allow coolant to drain out of the fitting.



7. If equipped, remove the four (4) nuts and the strut tower cross brace (15 mm socket). The strut tower cross brace cannot be reused after the supercharger has been installed. Discard the nuts and cross brace.





8. Use a screwdriver to remove the plastic cups exposing the fasteners holding the cover down. Unbolt the cover and pull up to remove it from the grommets. Remove the two (2) bolts (10 mm socket) securing the cover.

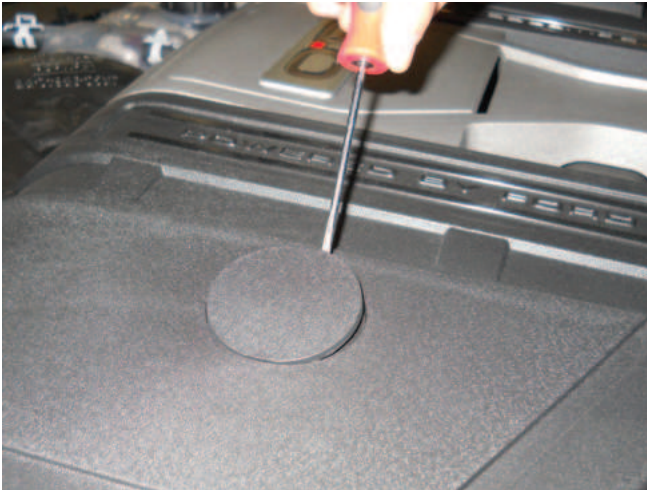

9. Gently pry up the push pin securing the induction resonance tube to the strut tower. Remove the mounting nut at the base of the induction resonance tube at the firewall (10 mm socket). Remove the induction resonance tube from the cowl. The induction resonance tube will not be reused.



Showing nut at firewall



10. Disconnect the brake aspirator line from the clean air tube.



11. Disconnect the positive crankcase ventilation (PCV) tube from the clean air tube.



12. Disconnect the PCV fresh air inlet tube from the LH cam cover and remove the tube from the vehicle.



13. Loosen the clamps securing the clean air tube at the airbox and throttle body. Remove the clean air tube from the throttle body and airbox lid. The clean air tube will not be reused.



**Clamp at airbox**



**Clamp at throttle body**



14. Remove the mass air flow (MAF) sensor connector by pulling the red locking tab back and pressing down on the black release tab. Release the two (2) locking tabs securing the upper airbox lid to the lower airbox. Disconnect the MAF wiring harness retainer from the front edge of the upper airbox lid. Remove the lid from the vehicle and set it aside.



15. Remove the filter from the airbox. Remove the mounting bolt at the side of the airbox (10 mm socket). Pull up and remove the lower airbox from the vehicle. The airbox will not be reused.



16. Disconnect the brake aspirator.





17. Disconnect the throttle body electrical connector. Pull the red locking tab back; press the black release tab to disengage the lock.



18. Unlock the green connector and disconnect the evaporative emission canister purge valve (EECPV) tube and electrical connector (green). Remove the EECPV tube retainer from the front LH cam cover.



**EECPV electrical connector**

19. Disconnect EECPV from the intake manifold. Remove the valve/tube assembly and set aside.



**EECPV tube quick connector with green lock**

20. Remove the PCV purge line from the intake manifold and RH cam cover. This line will not be reused.



21. Disconnect the fuel supply hose from the fuel rail (2). Using a fuel line tool, remove the supply line to the DI pump (1).

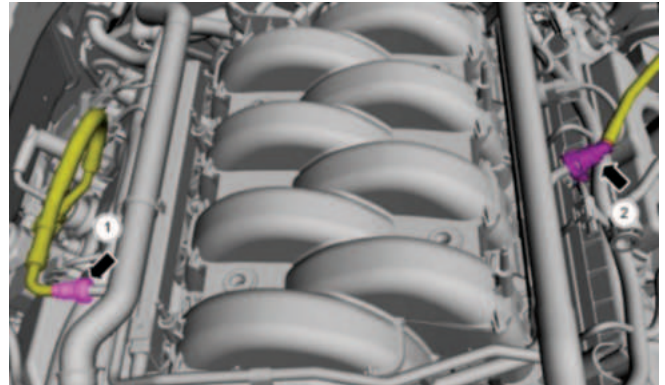

**NOTE:** Use a rag to catch any excess fuel during disconnection. Use a cap, tape or other suitable method to block the rail opening from contaminants.



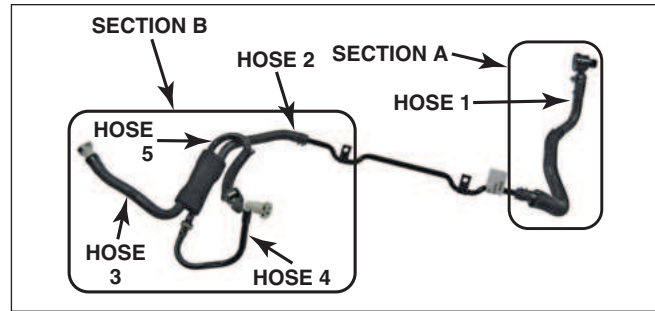

- 22. Move the LH heater hose aside from the support bracket on top of the LH cylinder head.
- 23. Remove the two (2) nuts that secure the brake boost vacuum hose and heater hose support bracket to the LH cylinder head.

26. Remove the LH heater hose support bracket and fuel rail cover from the LH side of the cylinder head.



24. Disconnect the brake boost vacuum hose from the port at the firewall.

27. Remove the two (2) nuts (10 mm socket) and support bracket that retained the RH heater hose above the RH fuel rail. This hardware will not be reused. Remove the fuel rail cover from the RH cylinder head.



25. Remove the brake boost vacuum hose/line from the vehicle and set it aside. This line will be modified later.

28. Disconnect the heater feed and return hoses located at the front of both the LH and RH cylinder head intake flanges.





LH

29. Disconnect the electrical connector from the fuel pressure sensor.



30. Disconnect the clamps on the hose ends and remove the 3/8" engine coolant degas hose from both the engine and the degas bottle.



31. Remove the four (4) fuel rail bolts. These bolts will be reused.



LH



RH

32. Disconnect the eight (8) fuel injector electrical connectors (four [4] on each side).



RH shown



33. Remove the fuel rail.

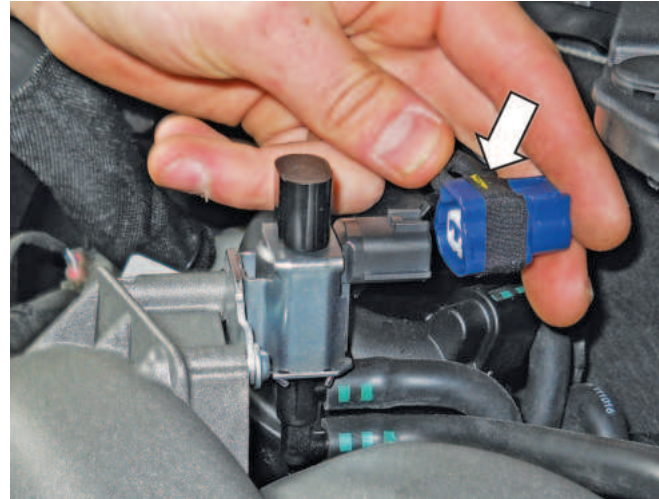
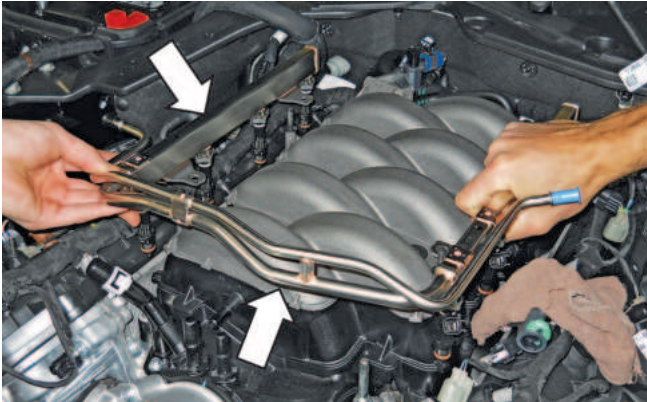

34. Remove the six (6) intake manifold mounting bolts (10 mm socket).



35. Lift the intake manifold straight up and pull it forward to access the harness connectors at the rear. Disconnect the CMCV harness connector. Use a trim tool to remove the harness from the intake. Use care – Do not cut the harness. Disconnect the four (4) harness connectors. Release/remove the two (2) push pins.







**Pin retainers on harness**

36. Remove the intake manifold from the vehicle.



37. Clean the intake mounting surfaces and apply tape over the open intake ports to prevent engine contamination.

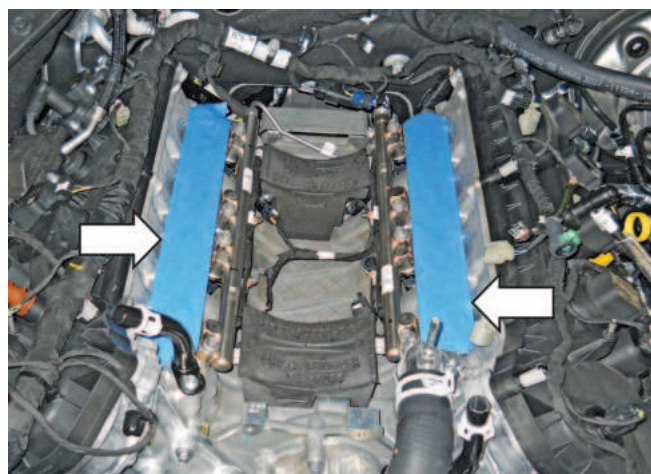
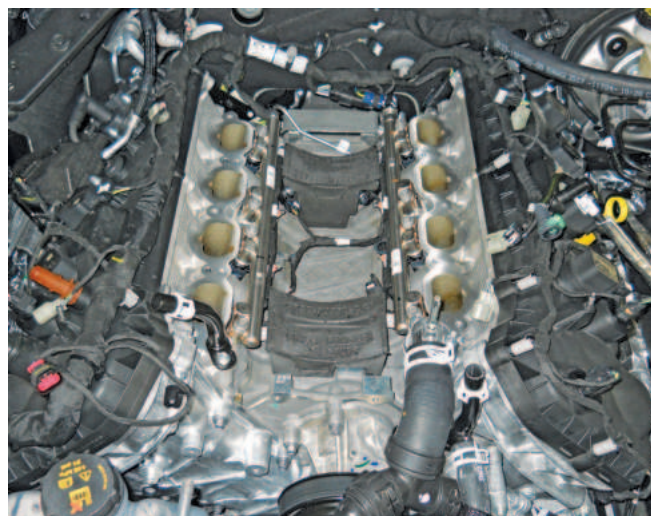

38. Disconnect the vent hose from the engine coolant degas bottle and at the water pump inlet.



**Degas vent**





**Degas hose from bottom of bottle**

39. Disconnect the clamp on the end of the upper radiator hose at the radiator. Use a rag to catch excess coolant. On the thermostat housing end of the hose, push the clip down on the connector and remove the upper radiator hose from the vehicle.

**CAUTION**

Some coolant will still be inside the hose. Use a rag to catch coolant when removing the hose.



40. Disconnect the electric fan harness connector on the cooling module. Remove the two (2) bolts (10 mm socket) securing the shroud to the cooling module, then remove the electric fan and shroud assembly from the vehicle.

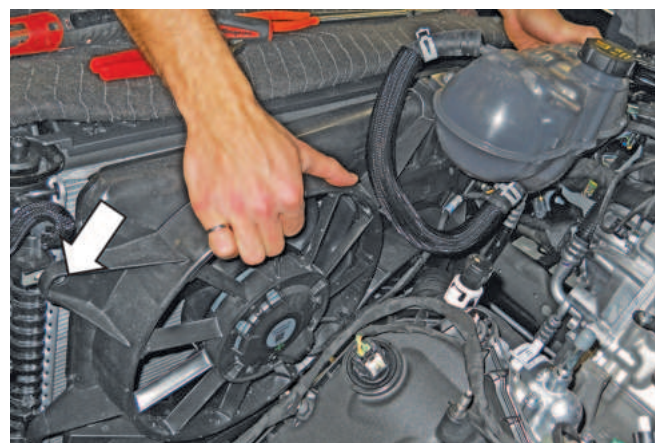

41. Remove the front end accessory drive (FEAD) belt. Rotate the FEAD tensioner counter-clockwise to release the belt tension and remove the belt (15 mm socket). Set the belt aside as it will be reused.



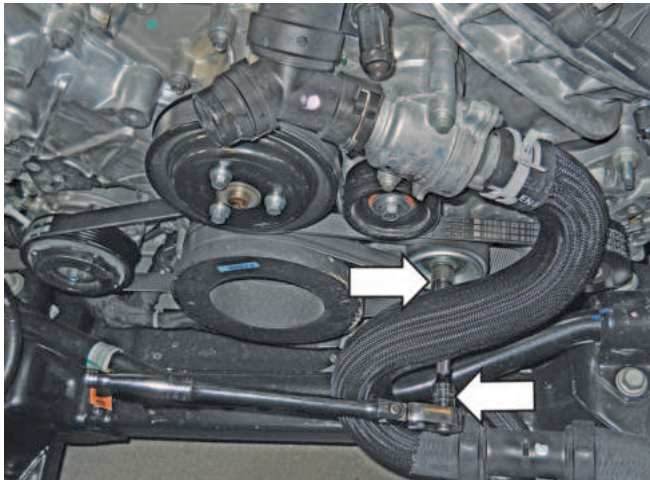

43. Cut and remove the A/C compressor belt. Discard the belt.



**NOTE:** Keep the front accessories and components clean. Wipe up any residual coolant.

44. Unclip the engine electrical harness retention clips that retain the engine harness to the top corners of the RH (passenger side) front cover.

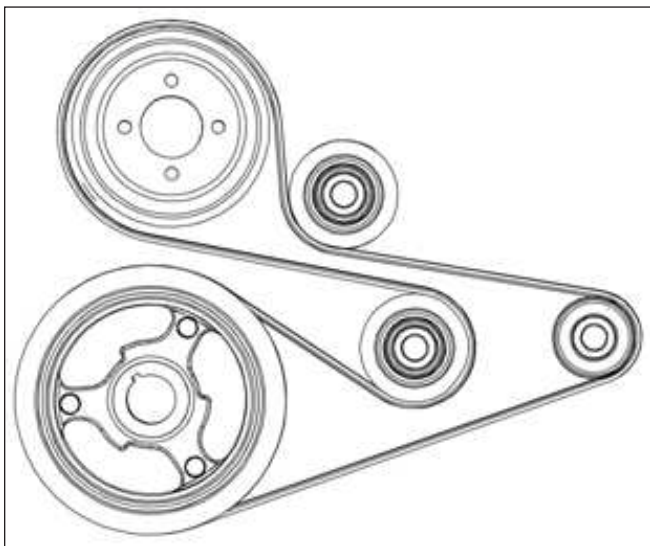

42. Remove the three (3) bolts (10 mm socket) securing the water pump pulley to the engine and remove the water pump pulley.



45. Cap or tape off the PCV port, heater feed tube.



46. Tape off the radiator hose port and inlet port.





### SECTION B – MODIFICATIONS

The following section will guide you through the required modifications of existing components and the build up of the assemblies used to complete the installation. With the exception of the wiring modifications and intercooler pump bracket mounting, all of this work can be performed away from the vehicle.

#### BRAKE BOOSTER VACUUM AND ASPIRATOR HOSE ASSEMBLY MODIFICATION

1. Retrieve the brake vacuum hose and aspirator assembly and place it on a work bench.
2. Disassemble the vacuum hose assembly and lay it out on a bench as shown in the following steps.

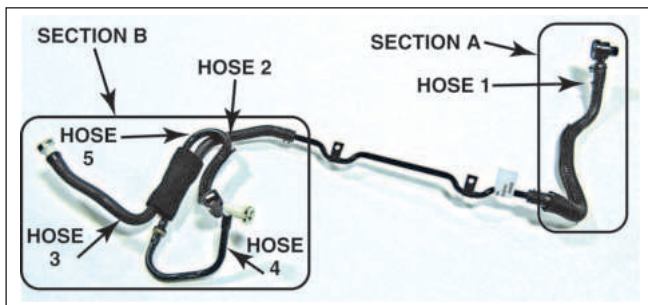

3. Release the clamp and remove Section A, Hose 1, from the brake booster hose and aspirator assembly. Keep all of the clamps, they will be reused.
4. Release the clamp and remove the check valve from the straight end of Hose 1.

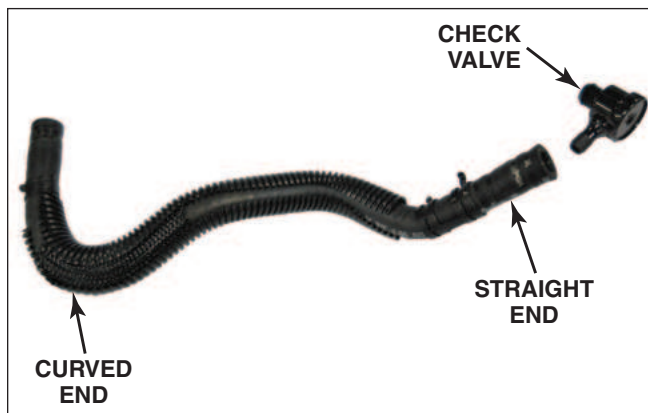

5. Release the clamp and separate Section B, Hose 2, from the steel tube.
6. Return to Section B of the hose/tube assembly. Carefully remove the foam sleeve from the brake aspirator.

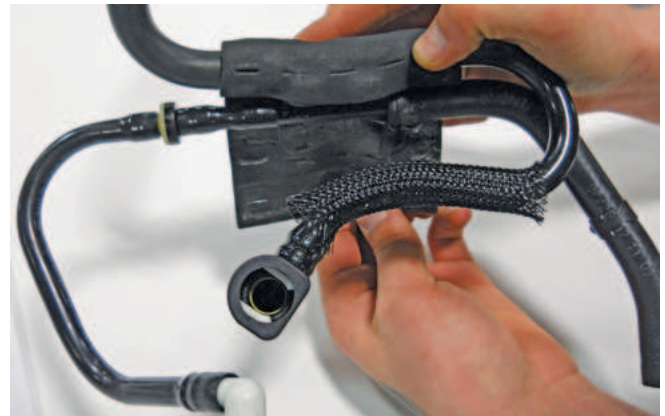

7. Disassemble the remaining brake aspirator assembly. Keep all of the clamps since they will be reused.



8. Use the brake aspirator plug (CS2575, found in 1318-TVSHWKD) to plug the black port that is diagonal to the 1/2" grey port of the aspirator assembly.

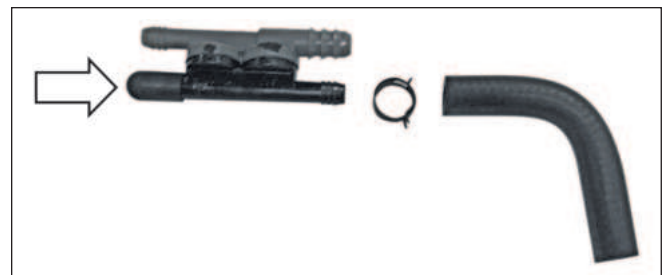

9. Use the takeoff clamps and attach them to the aspirator-to-brake booster hose (1318-9D690, found in 1318-KIT4).



10. Install the aspirator-to-brake booster hose (1318-9D690) into the black port on the brake aspirator assembly. Install the check valve that plugs into the brake booster. Secure the hose with the clamps as shown.



To Supercharger

12. Install the hose that goes to the clean air tube (1318-9D691, found in 1318-KIT4) into the remaining port on the brake aspirator assembly.



11. Install the line that goes from the supercharger to the aspirator assembly (1318-9D692, found in 1318-KIT4) into the 1/2" grey fitting on the aspirator assembly.

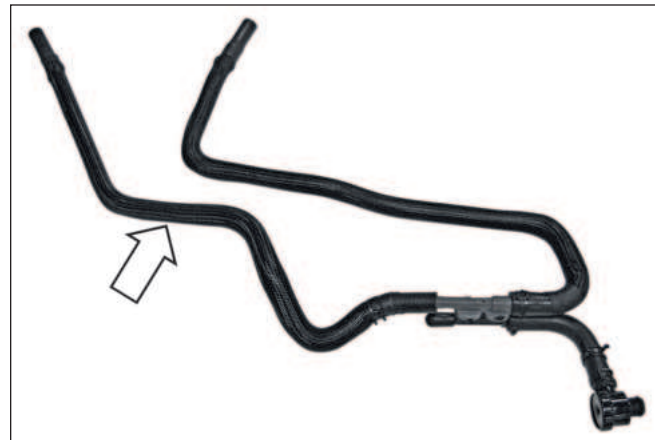

To Clean Air Tube

13. Cut and remove the connector from the PCV line.



14. Install the connector on the end of the clean air hose (1318-9D691).

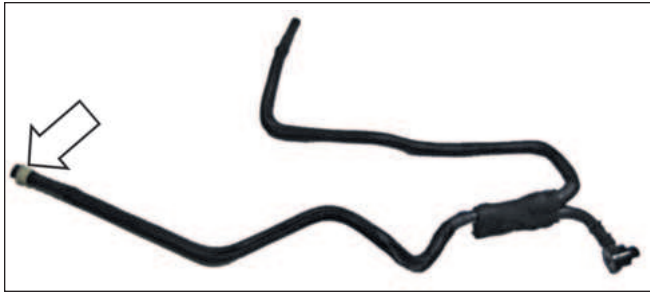

Connector

15. Re-install the foam on the brake aspirator assembly as shown.



#### EVAPORATIVE EMISSIONS CANISTER PURGE LINE

1. Cut and remove the line from the purge valve.



2. Install the extension hose (1318-9G272, found in 1318-KIT4) on the purge valve and secure it using one (1) clamp (7329K11, found in 1318-TVSHWKD).



#### ELECTRIC FAN SHROUD MODIFICATION

1. Print and cut out the template located on the last page of this manual. IMPORTANT: Print template to scale. Check scale by measuring reference line with a metric ruler.
2. Place the IC Degas Bottle Template on the top of the fan shroud. Line up the RH edge of template with center of the mounting hole on the right.
3. Use a spring-loaded punch or other suitable tool to mark the fan shroud for modification. Remove the template.



Right edge of template



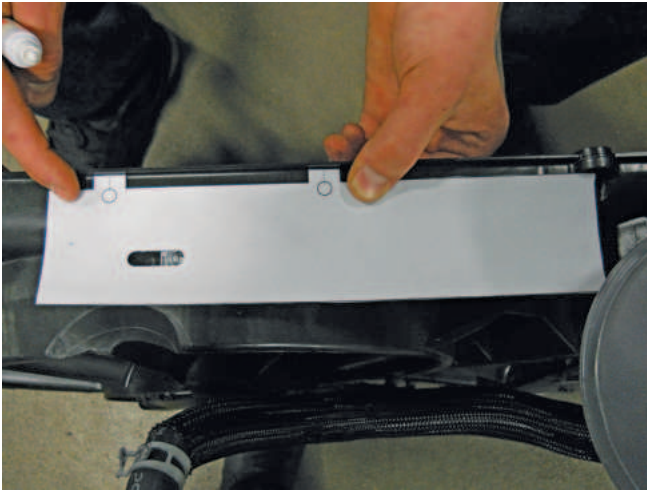

Proper template position on fan shroud



Reference marks from template

4. Use a dremel or other suitable tool to remove material in the three (3) rectangular areas marked as well as the two (2) holes.



5. Install two (2) J-clips (N623332, found in 1318-TVSHWKH) in the two (2) areas on the edge of the shroud.

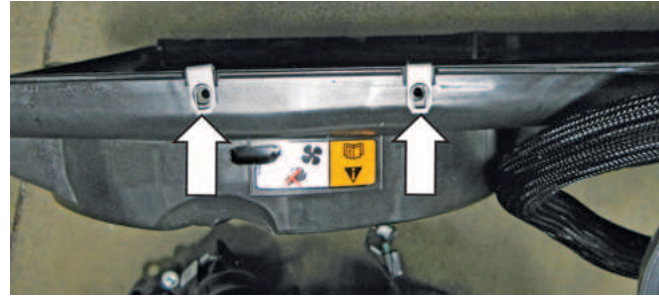

6. Insert the clip (20860 found in 1315-TVSHWKH) onto the tab on the bottom of the intercooler degas bottle (1318-8D080).

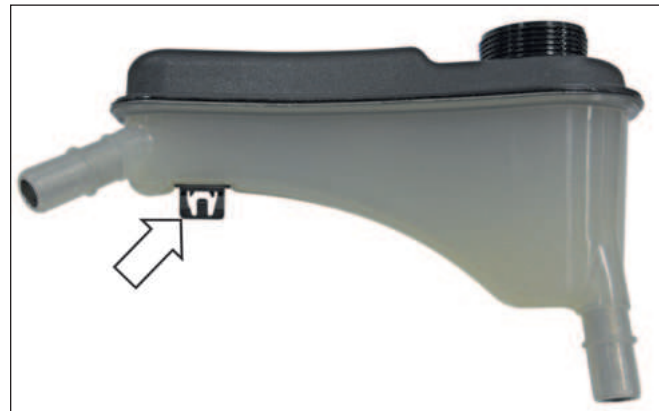

7. Check the fit of the intercooler degas bottle to the fan shroud, but do not install. Remove additional material as required to ensure proper fit.

#### FRONT COVER MODIFICATION

**⚠ WARNING**

**Wear safe eye protection when grinding to prevent serious personal injury.**

1. If not already done so, clean the engine surfaces with brake clean and dry with shop air.
2. Mask off the surrounding areas where the grinding will be performed to prevent debris and metal shavings from spreading through the engine compartment.





3. Locate the boss circled in red on the front cover. This boss needs to be reduced in height such that it is flush or lower than the height of the nearby rib structure. Apply reference marks on the boss to guide this modification.

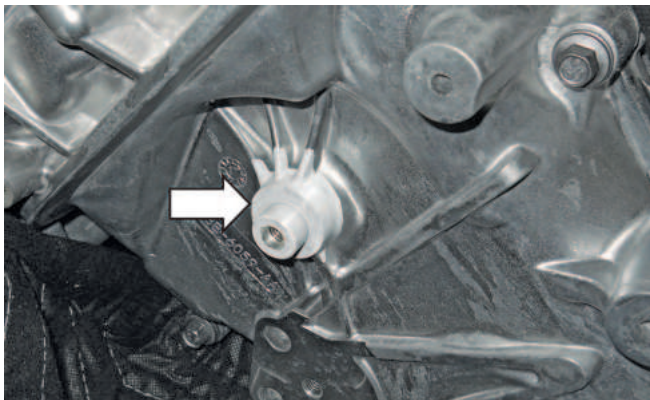

Before

4. Using a grinder or cut-off wheel, modify the front cover in the area shown. Check that the area where the boss was is now flush or lower than the height of the nearby rib structure.

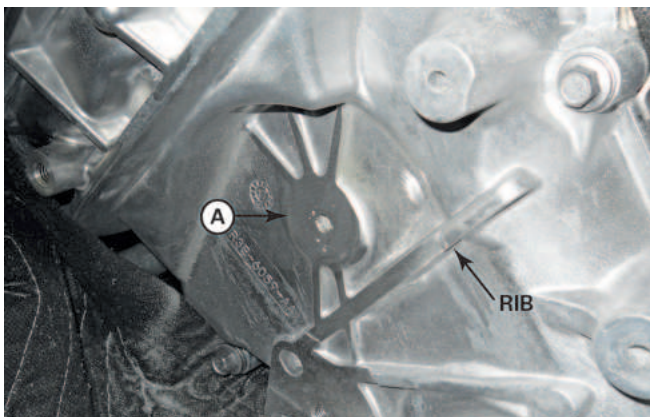

After

Surface A must be lower than or equal to the adjacent rib height. Refer to the following close-up example views for detail.

5. Locate the boss circled in green on the front cover. Drill the hole to a depth of 35 mm from the surface using a 6.9 mm drill bit. (The depth is important since it will be tapped to a depth of 25 mm minimum.)

**NOTE:** Drilling too deep could cause potential oil leaks.



6. Tap the hole using a M8x1.25 tap. Verify that the threads are at least 25 mm past the surface.



7. Vacuum out the metal shavings and clean the



area.

### INTERCOOLER PUMP HARNESS PROCEDURE

1. Obtain the intercooler pump electrical harness (1318-8W501, found in 1318-TVSHWKE). Route and tuck the pump harness under the engine harness along the RH cam cover. Continue routing the harness to the rear of the cylinder head and over to the driver side inboard cylinder head.

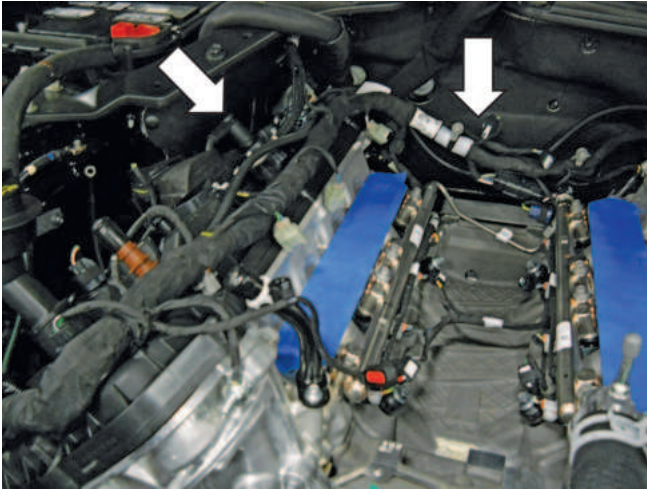

2. Connect the intercooler electrical harness to the blue connector that was attached to the IMRC solenoid.



3. Route the rest of the harness down along side the RH cylinder head back towards the fuse box.



4. Route intercooler relay harness near Battery Junction Box. Unclip inline connector and install relay harness on clip as shown. Use provided zip ties to route harness away from exhaust manifold. Re-install inline connector onto Battery Junction Box after mounting the relay.



5. Route the power and ground end of the harness over to the battery and fuse box.
6. Remove the ground wire bolt. Install the intercooler harness ground eyelet with the existing ground wire and reinstall the bolt.





7. Open the fuse box and remove the nut (10 mm socket) on the far post. Install the intercooler harness red power wire on the post and reinstall the nut.

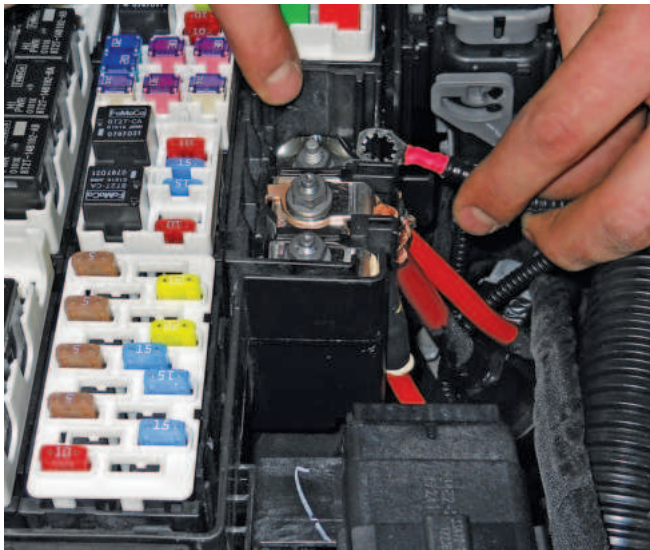

8. Route the other end of the harness down between the frame rail and washer bottle. The harness will later be connected to the intercooler pump.



**NOTE:** The extra slack in the harness will be taken out when zip tied.

#### MAF-TO-MAP HARNESS

1. Route the MAF-to-MAP harness (1318-12B579, found in 1318-TVSHWKE) behind the cylinder head.

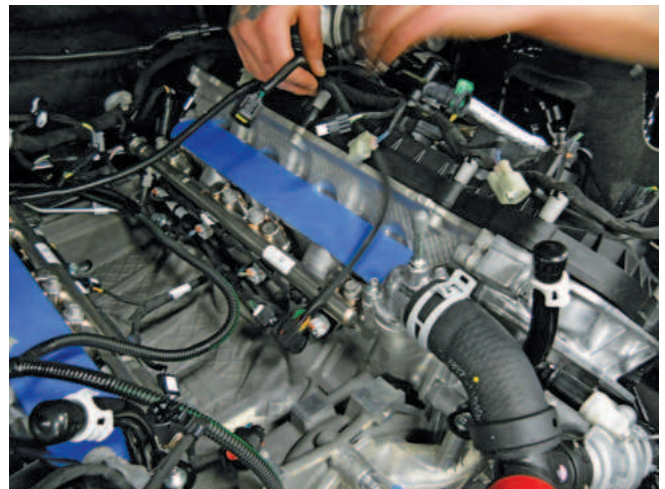

2. Plug in the two (2) small connectors from the harness behind the LH and RH cylinder heads.

**NOTE:** The wire color will match the correct IMRC connector. Verify the colors match during installation.



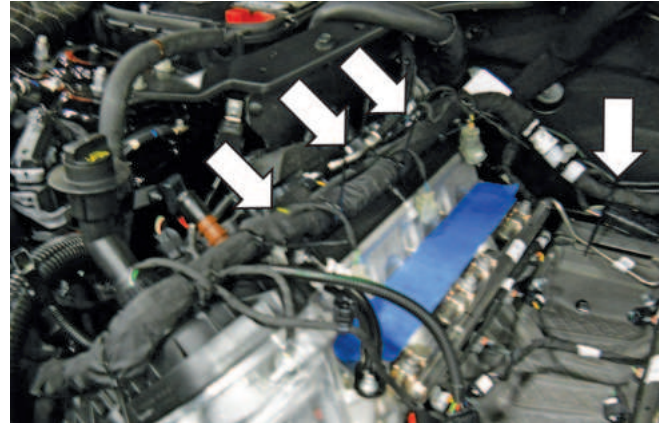
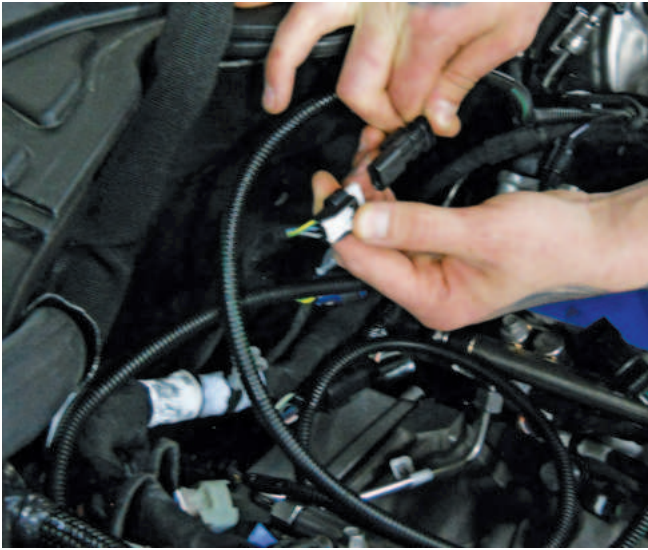

LH cylinder head

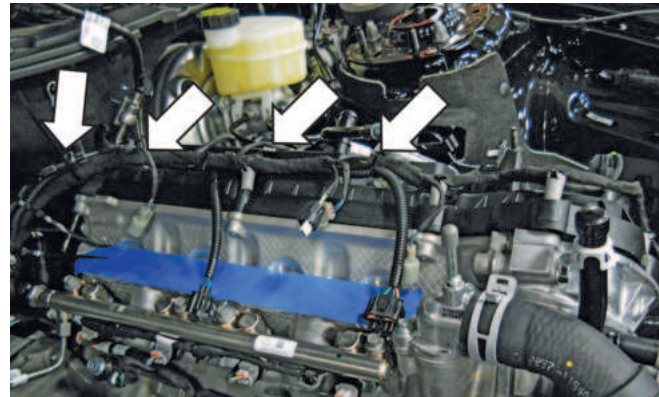

RH cylinder head

### MAP WIRES TO PCM CONNECTOR C175T

1. Disconnect the top PCM connector from the PCM. The connector is located near the wiper fluid bottle at the front of the vehicle.

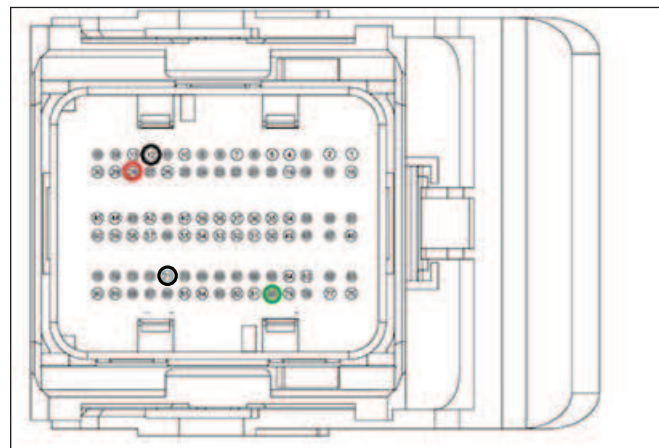
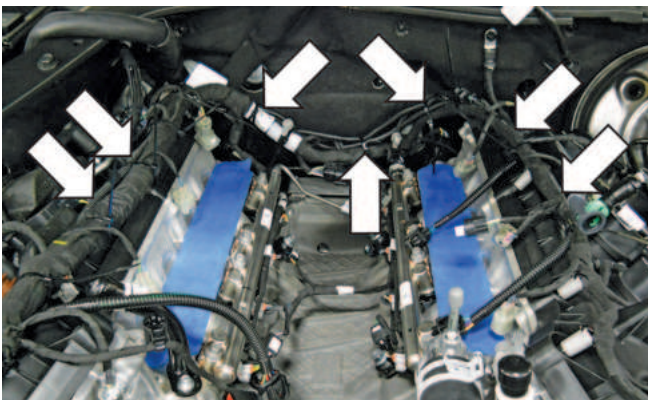



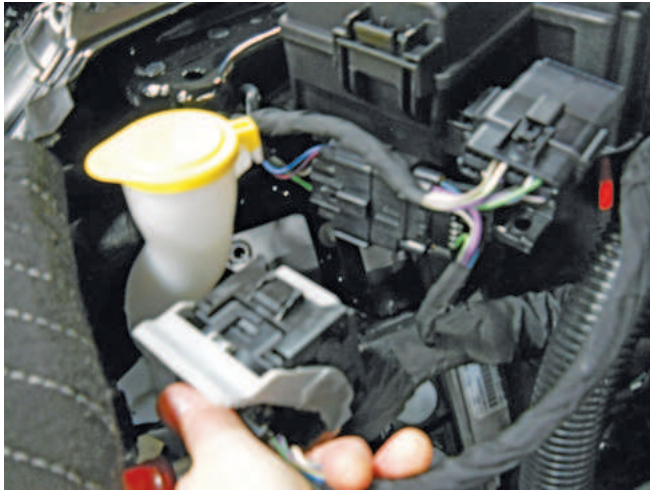

2. Depress the two (2) tabs and remove the cover off the back of the connector.



4. Punch out the blank in Pin 12. Insert the black wire from the 1318-12B579W harness and push in until you feel it lock in place.

**NOTE:** On some non-North America vehicles, Pin 12 may be populated already. Remove the brown wire and insulate the end with electrical tape. The black wire can now be installed.

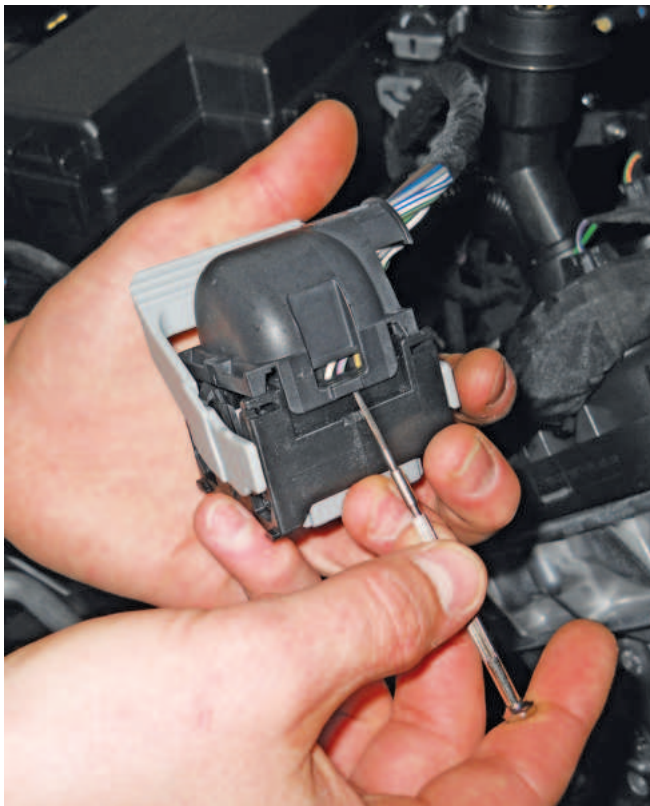

3. Remove the lock window from the connector by pushing it out from the backside. Pull the lock window off the front.

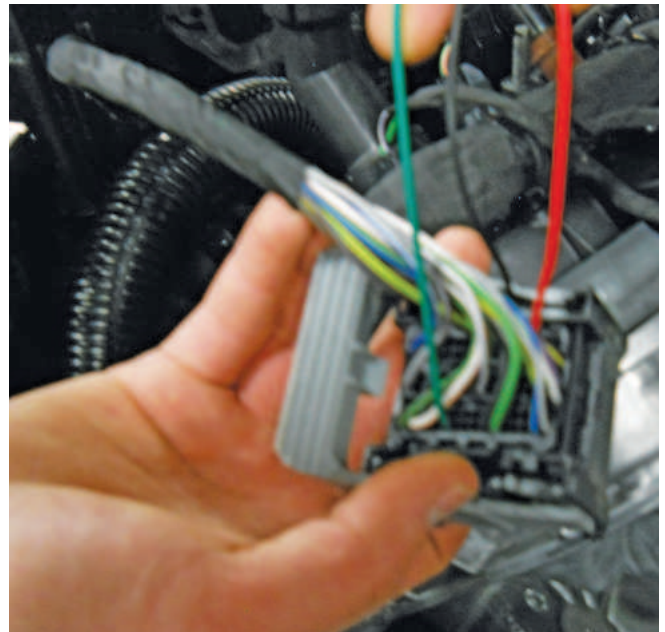





5. Punch out the blank in Pin 28 and install the red wire from the 1320-12B579WJ harness.
6. Punch out the blank in Pin 80 and install the green wire from the 1318-12B579W harness.
7. Punch out the blank in Pin 71 and install the black wire from the 1320-12B579WJ harness.

PIN #	Harness	Color	Description
12	1318-12B579W	Black	MAF to MAP harness
28	1320-12B579WJ	Red	Water temp jumper harness
80	1318-12B579W	Green	MAF to MAP harness
71	1320-12B579WJ	Black	Water temp jumper harness
Not used	1318-12B579W	Red	MAF to MAP harness

8. Reinstall the lock on the front of the connector.
9. Reinstall the cover on the back of the connector.
10. Plug the PCM connector back in.
11. Plug the jumper connector into the MAF-to-MAP Harness.



#### KNOCK SENSOR ORIENTATION ADJUSTMENT

The knock sensors must be reoriented and the harnesses rewrapped to accommodate the new fuel charging assembly. It will be necessary to split the four (4) sensor wires further up the harness in order to gain the necessary slack for proper sensor positioning.

1. Remove the two (2) push clips in the valley and cut them off the harness.





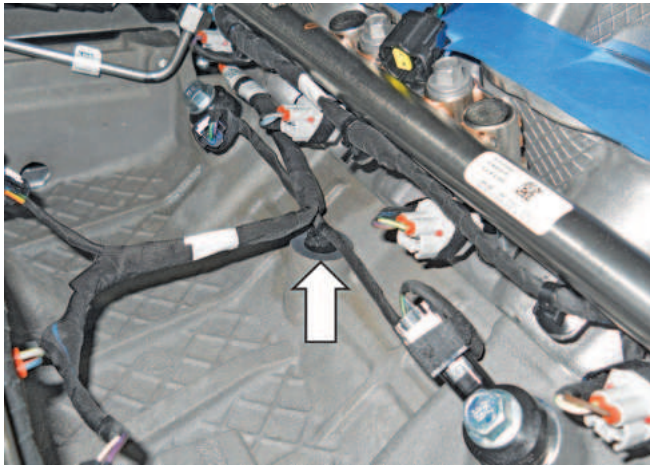

2. Cut the knock sensor harness back.

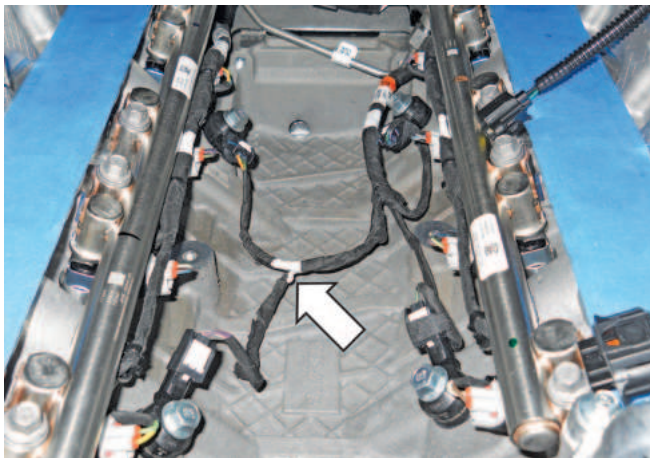

3. Remove the four (4) bolts which retain the knock sensors to the engine block (10 mm socket). Discard the bolts.
4. Temporarily fit the sensors as follows to determine where to rewrap the wires. Install and rotate the RH and LH knock sensors as far as possible to the outside of the valley of the block. Check that the sensors lay low on the engine valley so they will not interfere with the fuel charging assembly once it is installed.



5. Reinstall the convolute and rewrap the wires with electrical tape as required.
6. Install the knock sensors in position. (Point the connectors towards the center.) Install the new bolts (92095A292, found in 1318-TVSHWKB) and torque them to 20-30 Nm (5 mm Hex socket).

#### CHANGING THE FACTORY SPARK PLUGS

1. Disconnect the electrical connectors for each ignition coil (seven [7] places) (except cylinder 3).



2. Remove the seven (7) (except cylinder 7) fasteners holding the coil on plug assemblies in place (8 mm socket). Save the fasteners for re-use.





3. Remove the coil on plug assemblies and label them so they can be reinstalled in their original positions. A slight twisting motion will break the seal and ease removal.

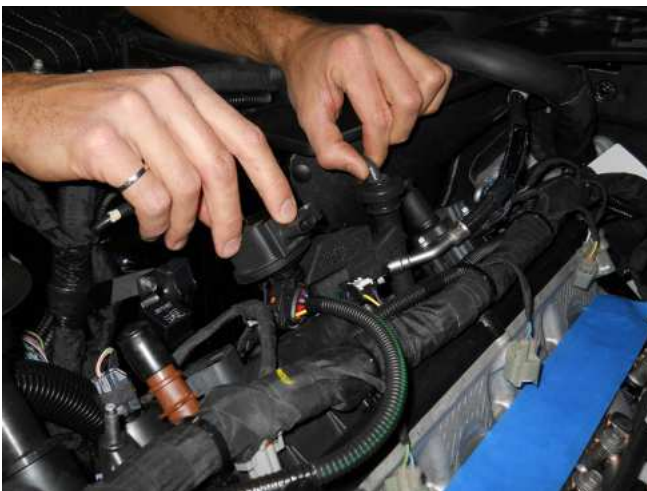

4. Use a 5/8" spark plug socket and 6" extension to remove the eight (8) factory spark plugs and set them aside. The spark plugs will not be re-used.

**NOTE:** Use a universal swivel socket at the rear RH plug.



5. Unpack the eight (8) provided spark plugs (M-12405-M50A) which are pre-gapped to 0.028-0.031" (0.7-0.8 mm). Check to ensure the gap is intact and none are damaged.





6. Install the new spark plugs using a 5/8" spark plug socket and 6" extension. Torque to 14 Nm.

**NOTE:** Use a universal swivel socket for the RH rear plug.

**NOTE:** Verify spark plug gap is 0.028-0.031" (0.7-0.8 mm).



7. Apply a small amount of dielectric grease to the inside of the coil on plug boots before attaching to the spark plugs. Install the ignition coil on plugs in their original position. Install the coil on plug bolts and torque to 6 Nm.

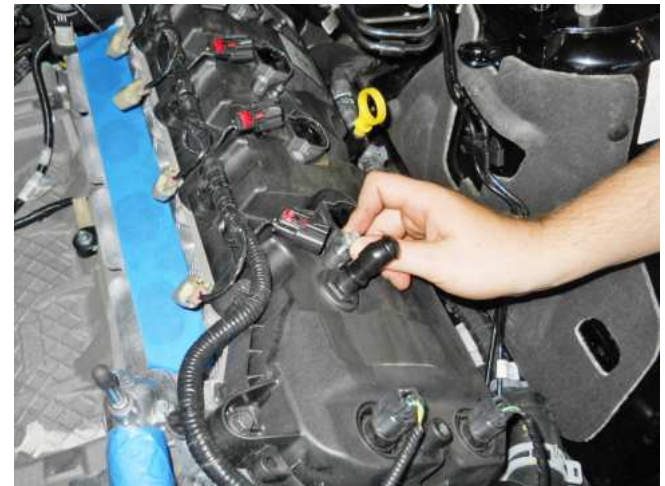

8. Connect the electrical connectors for each ignition coil in seven (7) places.

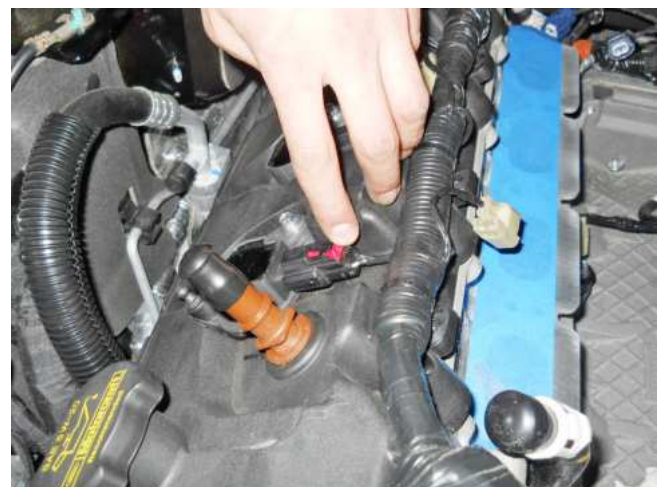

9. Locate two (2) spark plug warning labels (PT00045644, found in 1121-HWKF). Place 1 label on cylinder 1 and cylinder 5 coils (front coil of RH and LH cam cover).



SECTION C – SUBASSEMBLY  
INTERCOOLER LOW TEMPERATURE  
RADIATOR (LTR)

1. Insert one (1) rubber grommet (R07060107, found in 1318-TVSHWKH) into each lower tab on the low temperature radiator (LTR) assembly (1318-8K229).

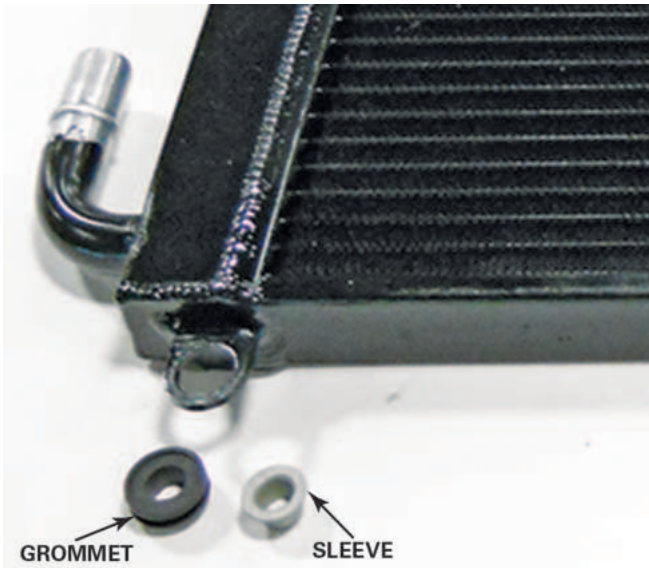

2. Push one (1) sleeve (R07060108, found in 1318-TVSHWKH) into each of the rubber grommets.

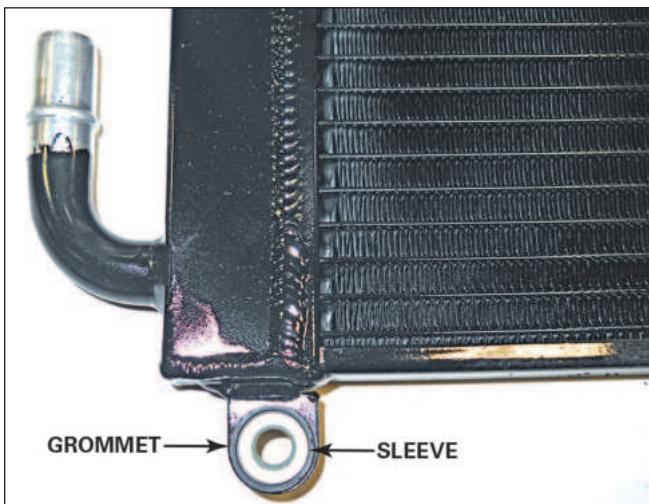

3. Turn the LTR over. Apply foam seal stripping (1318-8K230, found in 1318-TVSHWKH) to all sides of the LTR frame as shown.

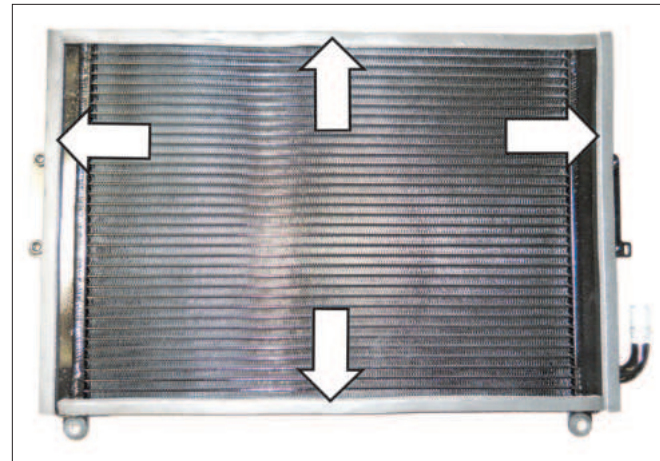

4. Apply 1" foam strips (1318-8D082, found in 1318-TVSHWKH) to the inside of the two (2) intercooler pump upper brackets (1318-8C4192, found in 1318-TVSHWKH).



5. Apply two (2) 1"-size foam strips (1318-8D082) to the inside of the intercooler pump lower bracket (1318-8C4191, found in 1318-KIT1).



6. Install the grommets (R07060107-13) and sleeves (R07060108-13) into the upper LTR brackets (1318-8K242 and 1318-8K243, found in 1318-KIT1).



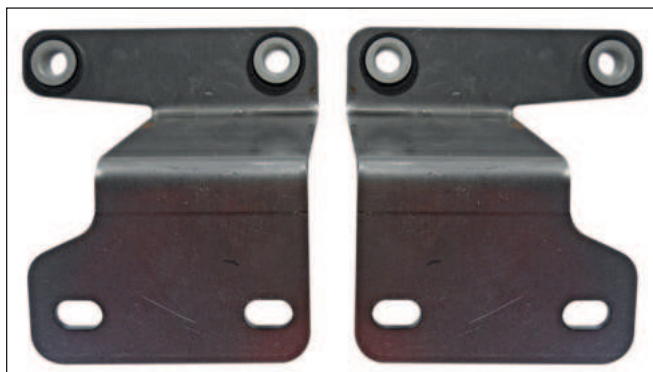

### RESERVOIR BOTTLE PREPARATION

1. Install the 3/4" reservoir-to-pump hose assembly (1318-8D027, found in 1318-TVSHWKH) on the intercooler system reservoir bottle (1318-80081).

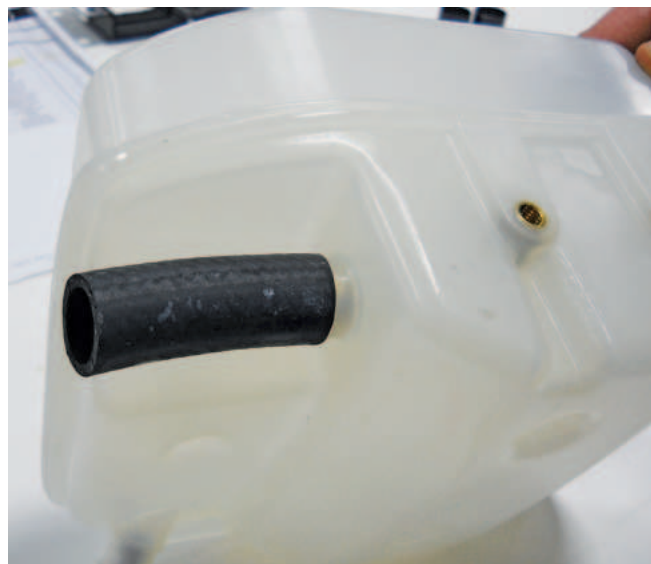

2. Install one (1) Constant tension clamp(CT19X12-BO), found in 1318-TVSHWKH) on the hose.



3. Apply two (2) foam strips (1318-8D082, found in 1318-TVSHWKH) onto the reservoir bottle as shown. **NOTE: Heat Shrink Clamp shown, kit includes constant tension version**



#### INTAKE MANIFOLD BUILDUP

1. Obtain the PCV purge hose (1318-6K817, found in 1318-KIT4). Release the clamp and separate the rubber section of hose as shown.



2. Attach the rubber hose section from the PCV purge hose to the bubbler fitting (3/8" barb) on the bottom rear of the intake manifold (1318-9H487) and secure it with the supplied clamp.

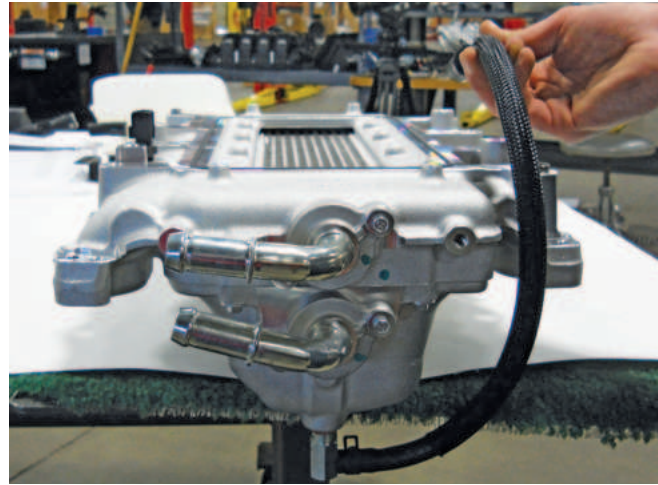

#### SUPERCHARGER BUILDUP

1. Connect the supercharger boost bypass actuator hose (1315-9E498, found in 1315-TVSHWKD) to the top port on the actuator and route to the small port on the supercharger (1318-6F066).



2. Install the SIP sensor (CV2A-9F479-AA) into the side of the supercharger and secure it using one (1) bolt (N807309-S437, found in 1318-TVSHWKB). Torque to 10 Nm (10 mm socket).

**Important:** Do not confuse the sensor and fastener with identical parts.





throttle body to the supercharger. Torque to 10 Nm (10 mm socket).



5. Install the supercharger badge (1318-6F066BDG, found in 1318-TVSHWKG) onto the top of the supercharger.



3. Install the O-ring/gasket (1318-9E936, found in 1318-TVSHWKB) into the groove on the supercharger.



#### FUEL RAIL ASSEMBLY

1. Carefully install the eight (8) take-off anti-rotation fuel injector clips onto the new fuel injectors (13119F593K, found in 1318-KIT2).

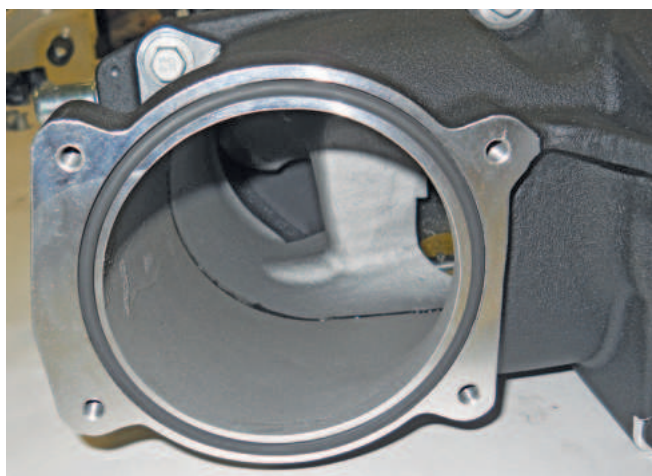

4. Install the throttle body (FR3Z-9E926) on the supercharger, making sure the part orientation is correct with the plug under the pulley. Install four (4) M6x1.0x45 mm bolts (161817) to secure the



2. Apply a little engine oil or petroleum jelly to the Injector O-rings and install the injectors into the new fuel rail (1318-9F792, found in 1318-KIT2).

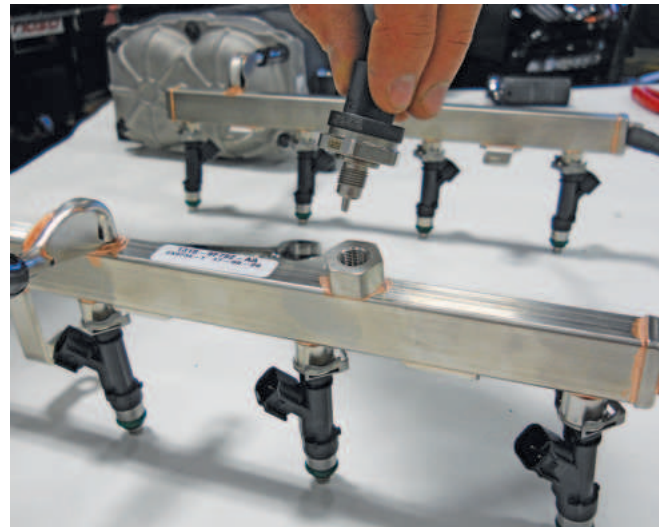

4. Install the pressure sensor in the new fuel rail. Hold the nut with a 19 mm wrench and use a 27 mm socket to tighten as follows.  
Stage 1: Torque the nut to 53 lb-in (6 Nm).  
Stage 2: Angle tighten the nut 25 degrees.

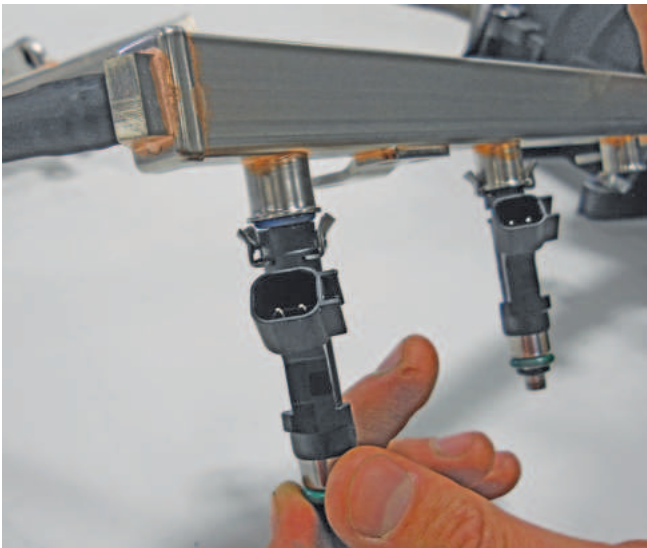

**NOTE:** Verify that the anti-rotation clips are properly aligned and fully engaged into the fuel rail injector cups.

3. Remove the pressure sensor from the stock fuel rail (27 mm socket).

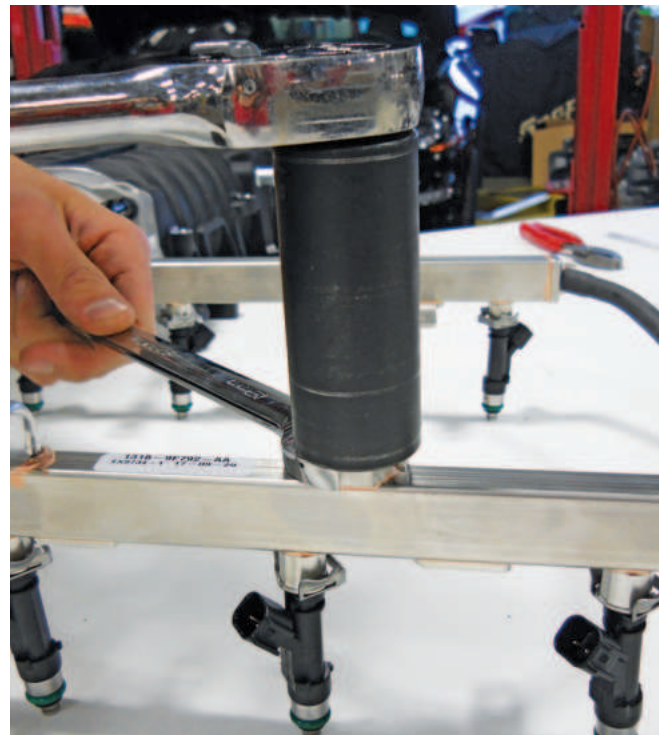





### AIRBOX ASSEMBLY

1. Install the filter (131550-9601R) onto the MAP tube (131537-12B579) and secure it with the supplied clamp. Torque clamp to 3-5 Nm (8 mm socket).



2. Place the MAP tube assembly (131537-12B579) through the opening of the airbox tray (131550-9A612) from the inside.

3. Align the holes on the MAP tube assembly with the molded bolts on the airbox tray. Install two (2) M8x25 bolts (W500224, found in 1318-TVSHWKA) and torque to 10 Nm (10 mm socket).

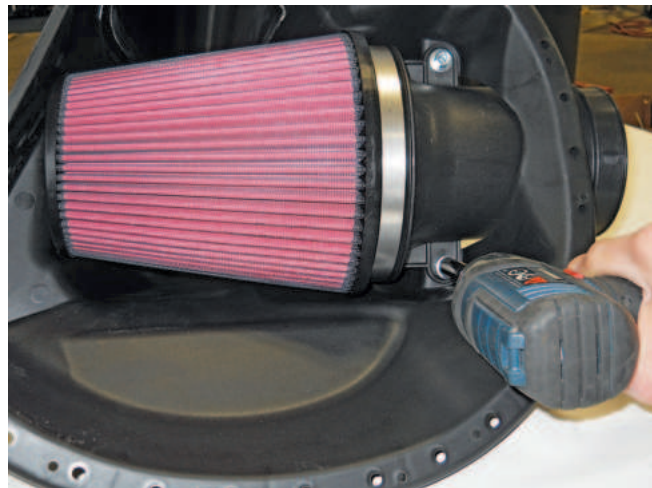

4. Remove the grommets and sleeves from the factory lower airbox. Install the grommets and sleeves onto the new airbox assembly.

**TIP:** Remove the center bushing while installing the rubber grommet through the hole in the tab. Re-install the center bushing once the grommet is fully seated.



Factory airbox

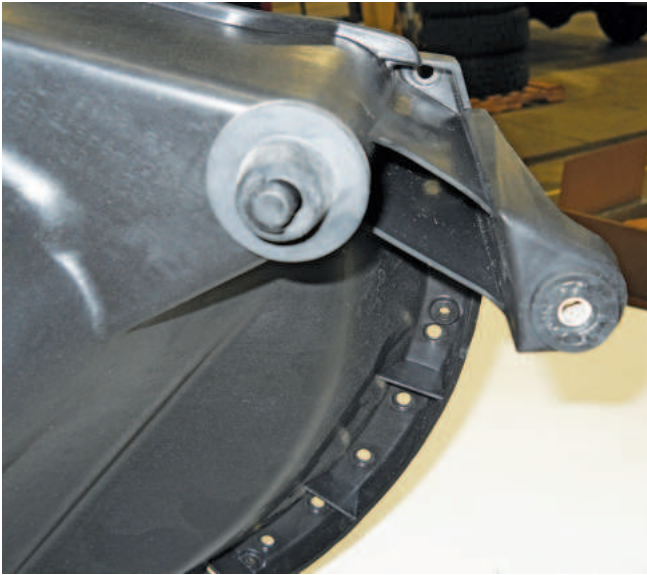

**New airbox**

5. Remove the rubber mounting Isolator from the bottom of the factory airbox and install it onto the mount on the bottom of the new airbox in the same orientation.



#### INTERCOOLER HARD LINE ASSEMBLY

1. Set the intercooler hard line assembly (1318-8D028, found in 1318-KIT4) on a work bench.



2. Install the 3/4" jumper hoses (1318-8D032, found in 1318-TVSHWKH). Install one (1) Constant tension clamp band (CT19X12-BO), found in 1318-TVSHWKH) over each hose.



#### CRANKSHAFT PULLEY REPLACEMENT

**NOTE:** After crankshaft pulley installation, it will be necessary to relearn the misfire profile correction using RDT. Refer to the RDT-CALIM included with your ROUSHcharger kit.

##### **Pulley Removal**

1. Loosen the crankshaft pulley bolt and washer.

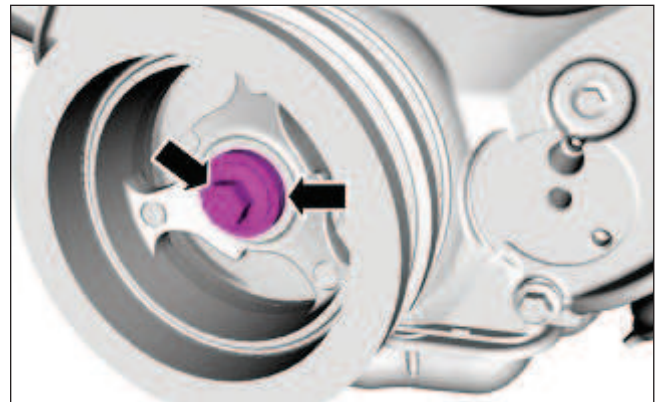

2. Using a 3-Jaw Puller and the crankshaft pulley bolt, remove the crankshaft pulley. Discard the crankshaft pulley bolt.



##### **Pulley Installation**



**NOTE:** If not secured within 5 minutes, the sealant must be removed and the sealing area cleaned with silicone gasket remover and metal surface prep. Failure to follow this procedure can cause future oil leakage.

1. Apply silicone gasket and sealant to the Woodruff key slot in the crankshaft pulley (JR3Z-6312-A).



2. Lubricate the crankshaft pulley sealing surface with clean engine oil prior to installation.



3. Using a suitable Damper Installation Tool, install the crankshaft pulley.

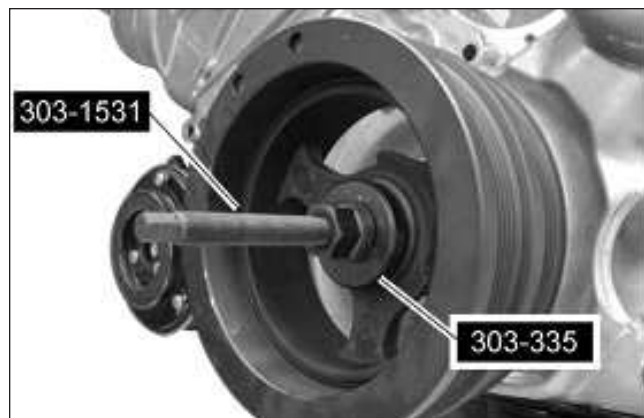

4. Using the Strap Wrench, install a new crankshaft pulley bolt (BR3Z-6A340-A) and the original washer. Tighten the bolt in four (4) stages:
  - Stage 1: Tighten to 140 Nm.
  - Stage 2: Loosen 360 degrees.
  - Stage 3: Tighten to 100 Nm.
  - Stage 4: Tighten an additional 90 degrees.

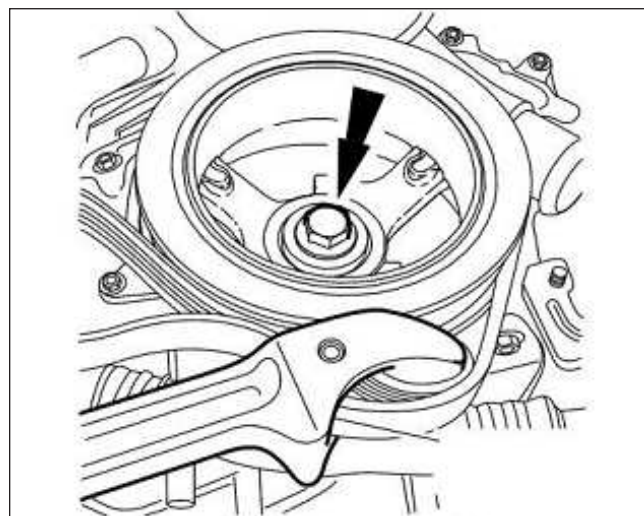

## SECTION D – INSTALLATION

The following section will guide you through the final installation of the kit into the vehicle. If you need to stop during any part of the installation, make sure you cover any open ports in the cylinder heads or intake manifold to prevent foreign material from contaminating the engine.

### INDUCTION RESONANCE TUBE DELETE GROMMET

1. Obtain the induction resonance tube delete grommet (W651016, found in 1318-TVSHWKA).
2. Install the induction resonance tube delete grommet in the hole that was exposed when the resonance tube was removed.



4. Loosen the bolt and rotate the ground wire, pointing it towards the brake booster, then retighten the bolt.

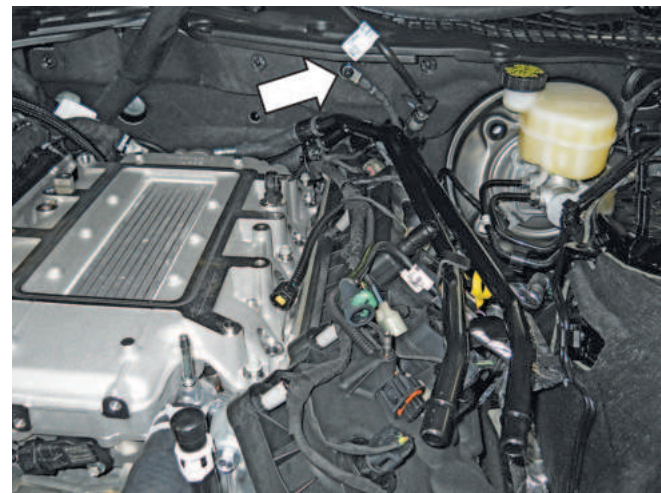

5. Loosely install the six (6) M6x1.0x40 mm bolts (R18020004, found in 1318-TVSHWKB) in the intake manifold in the positions shown. Do not tighten yet.

### INTAKE MANIFOLD AND FUEL RAILS

1. Remove the tape from the cylinder heads and clean the cylinder head-to-intake manifold mating surfaces.
2. Install the fuel charging assembly (1318-9H487) and check to make sure it is seated completely. Route the PCV hose under the DI fuel rail as the intake manifold is being slid into position.

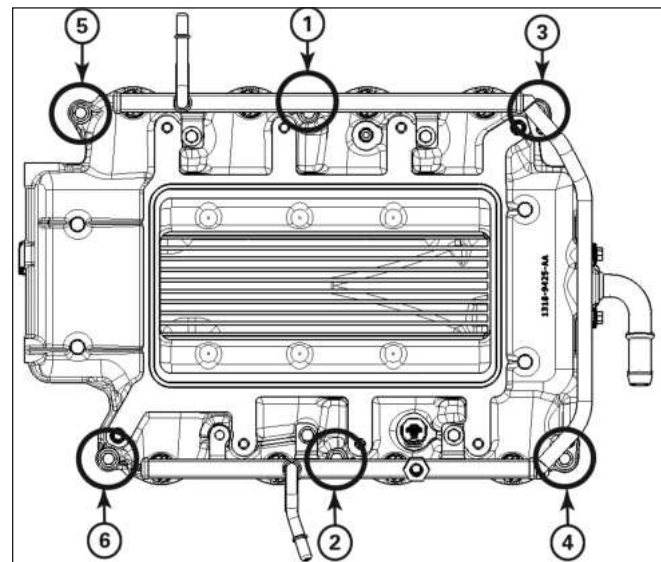
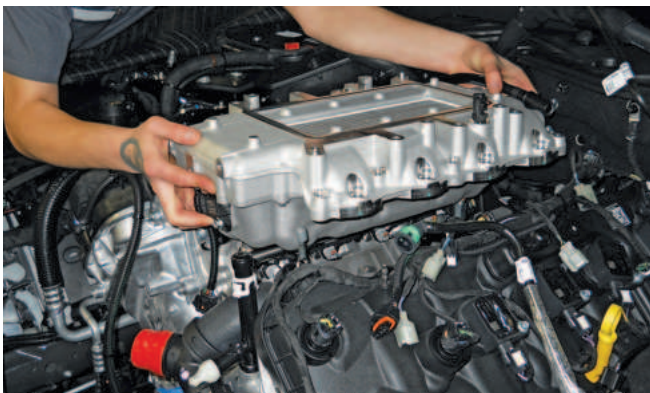

#### Intake manifold bolt tightening sequence

3. Plug in the connector to the MAP sensor on the front of the intake manifold.
6. Install two (2) clamps (CT19X12, found in 1318-TVSHWKH) on the tubes at the rear of the intake manifold. These clamps will secure the hoses from the intercooler hard line assembly when installed.



7. Temporarily place the intercooler hard line assembly (1318-8D028) in position on the LH valve cover and connect the hoses to the tubes on the rear of the intake manifold. Test the fit to ensure the hoses are not kinked.



NOTE: Check that the PCV hose in back of the intake manifold is routed around the DI injector crossover tube and towards the RH cam cover.



8. Once proper hose fit is obtained, tighten the six (6) M6x1.0x40 mm bolts (R18020004) (10 mm socket). Tighten the fasteners in two stages in the sequence shown.  
Stage 1: Torque the bolts to 10 Nm.  
Stage 2: Tighten the bolts an additional 45 degrees. Reinstall the engine wiring harness retention clips at the rear of the intake manifold.



9. Remove the bolt (8 mm socket) from the coil cover.



Place the intercooler hard line assembly in mounting position and reinstall the bolt. Torque to 6 Nm.





10. Secure the CAC hoses at the rear of the intake manifold with the two (2) clamps (CT19X12).

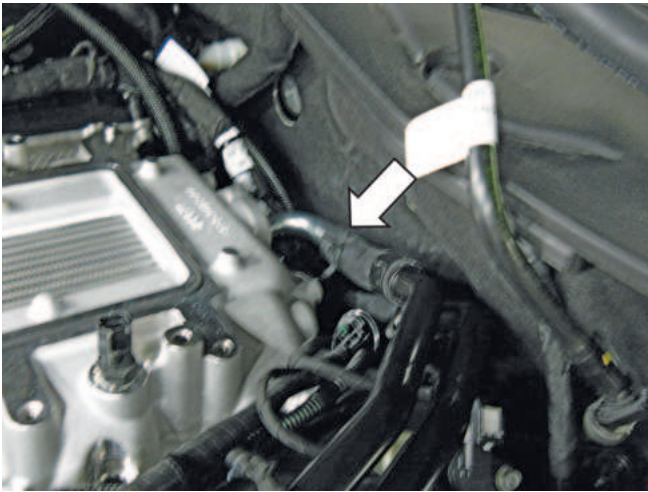

11. Connect the ACT sensor to the ACT harness (1318-12B579W).



12. Lubricate the lower fuel injector O-rings with petroleum jelly or engine oil. Install the fuel rail and injectors into the intake manifold. Be sure each injector is properly seated into the intake manifold. Install three (3) previously removed fuel rail mounting bolts into three (3) of the four (4) fuel rail mounting locations (positions 1, 3 and 5 in the figure).

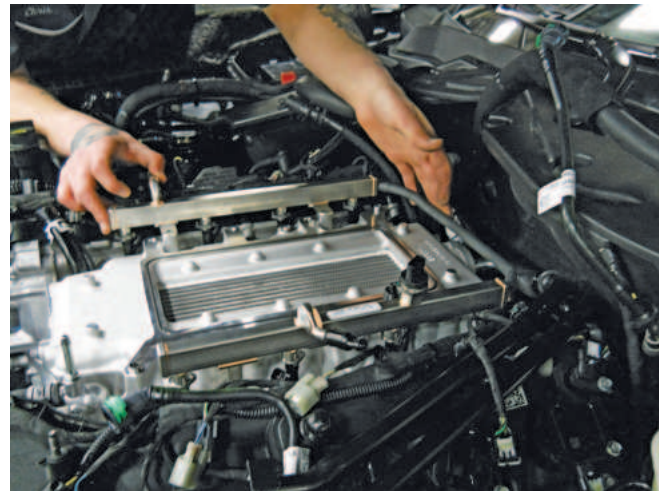

13. Install the M6x1.0x20 fuel rail-to-intake manifold bolt (BM6X20HF-S437) (short) at position 2 and M6x1.0x45 fuel rail-to-cylinder head bolt (161817) (long) at position 4. Tighten the bolts in two stages in the sequence shown.  
Stage 1: Torque the bolts to 10 Nm.  
Stage 2: Tighten the bolts an additional 45 degrees.

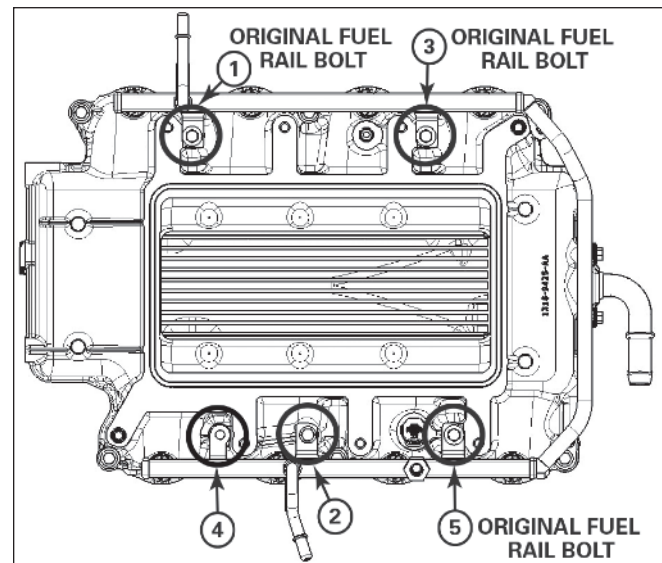

Fuel rail bolt tightening sequence





14. Connect the eight (8) fuel injector electrical connectors.



15. Plug in the connector to the fuel pressure sensor on the fuel rail.



### UPPER FEAD BRACKET

1. Place the upper FEAD bracket (1318-8B653U, found in 1318-KIT3) in position on the FEAD.



2. Install four (4) upper FEAD bracket-to-engine bolts (M8x1.25x60) (11116346). Install one (1) silver upper FEAD-to-intake (M8x50) bolt (W500313-S437), in the upper left corner. Torque to 25 Nm. All the bolts in this step are found in 1318-TVSHWKC.



3. Install the black 77 mm grooved idler pulley (900162, found in 1318-TVSHWKC) on the upper right of the FEAD bracket with one (1) idler bolt (M8x1.25x28\_large washer) (R18020060). Torque to 25 Nm. Install the silver 70 mm smooth idler pulley (FS00060235, found in 1318-TVSHWKC) on the lower left of the FEAD bracket with one (1) idler bolt (M8x1.25x28\_large washer) (R18020060). Torque to 25 Nm.





### SUPERCHARGER

**NOTE:** Make sure the O-ring on the upper intake manifold is in position and has not rolled out of the groove.

1. Partially set the supercharger in place over the intake manifold over the throttle body wire. Connect the throttle body connector and move the wiring out of the way.

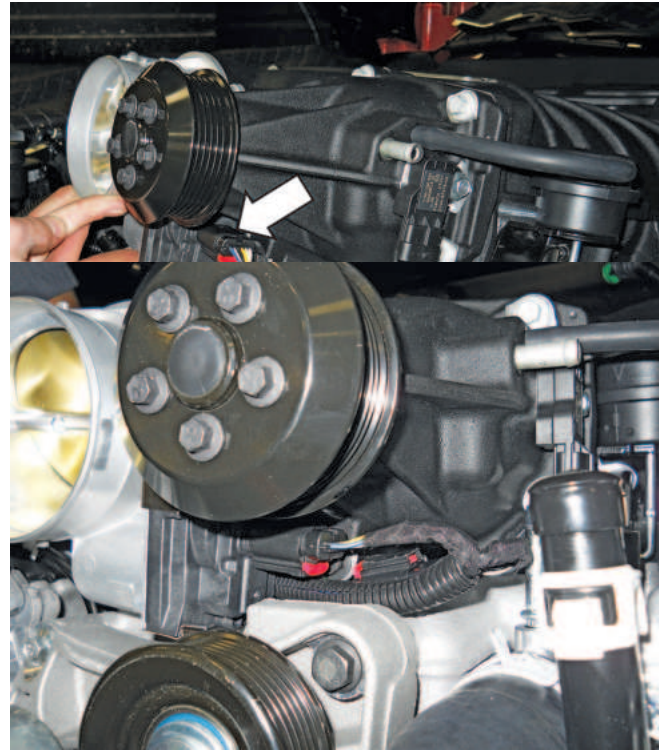
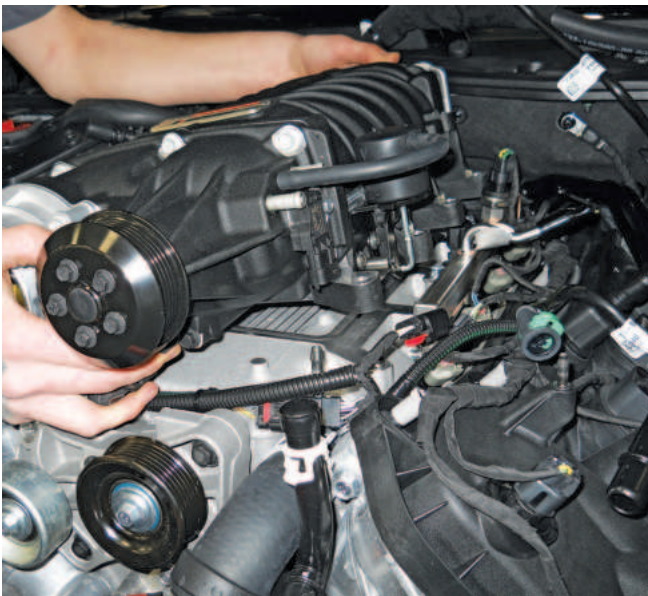

3. Install the provided eight (8) M8 fasteners (161826, found in 1318-TVSHWKB) into the mounting holes. Torque the fasteners to 25 Nm in the sequence shown (10 mm socket).







Connect the check valve on the brake vacuum and aspirator assembly to the brake booster.

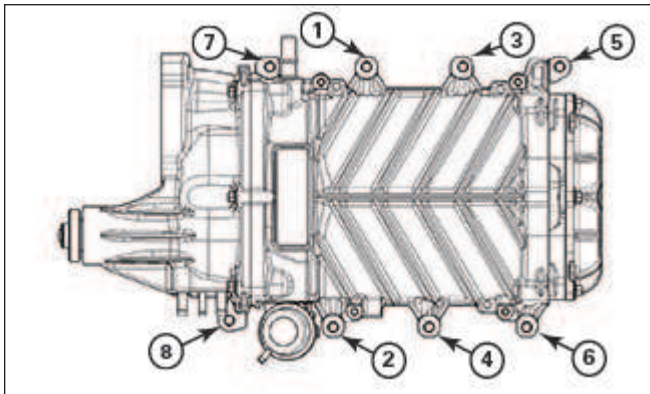

**Supercharger bolt tightening sequence**

4. Connect the SIP connector on the supercharger.

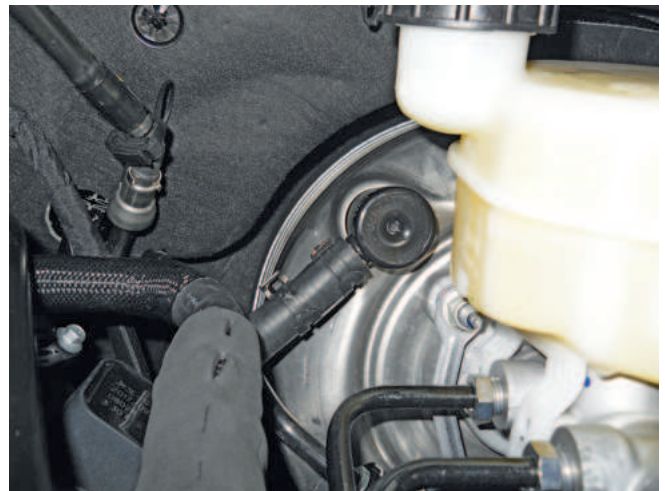

6. Install the brake booster hose assembly in the vehicle and inspect the fit to ensure there are not pinched hoses and the convolute is positioned to prevent hose abrasion from other components.



5. Place the brake booster hose assembly next to the supercharger, over the LH coil area.





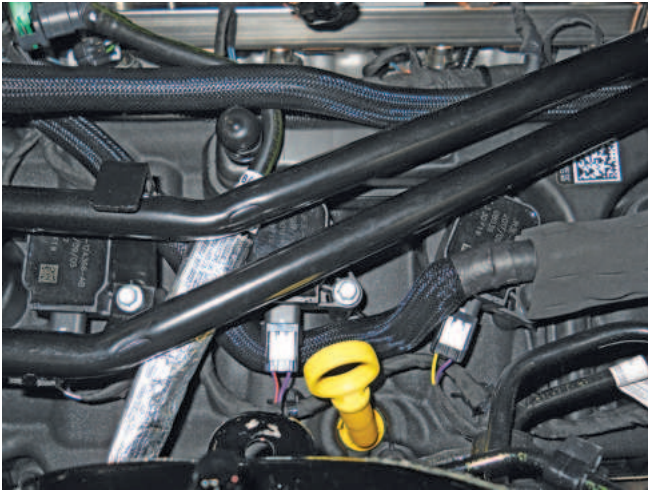

7. Connect the booster hose (1318-9D0692) to the supercharger and secure it with one (1) clamp (7329K11, found in 1318-TVSHWKD).

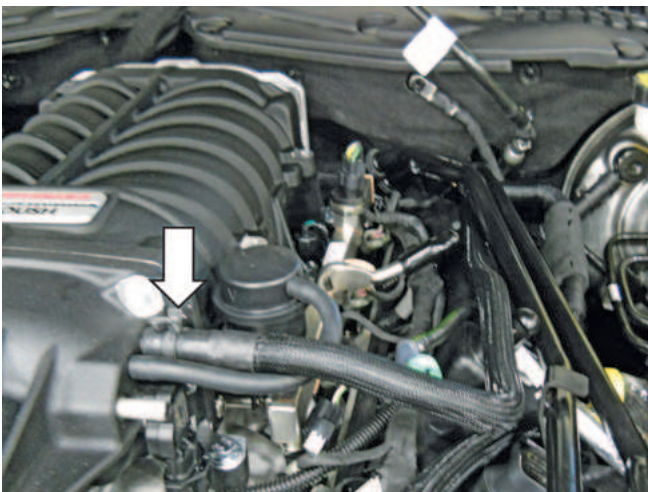

8. Install the hose (1318-9G272) between the supercharger and EECPV. Secure it with one (1) clamp (7329K11, found in 1318-TVSHWKD).

9. Install the connector to the EECPV. Install the purge line (with green connector) to the EECPV. Zip tie the EECPV to the engine harness.

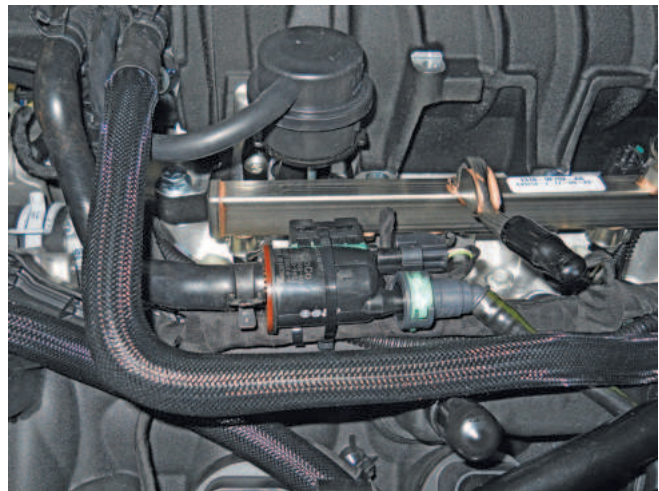

10. Install the fuel inlet line (green connector) to the tube on the LH fuel rail. Lock the connector.





11. Connect the high pressure fuel supply line to the RH fuel rail and lock it into position.



### HEATER CORE LINES AND COIL COVER BRACKETS

1. Install the LH coil cover bracket (1318-6P069, found in 1318-KIT1) on the supercharger. Install two (2) M6x1.0x20 mm bolts (BM6X100X20HF, found in 1318-TVSHWKB) on the bracket. Torque to 10 Nm (10 mm socket).



2. Install RH coil cover bracket (1318-6P070, found in 1318-KIT1) on the supercharger. Install two (2) M6x1.0x20 mm bolts (BM6X100X20HF, found in 1318-TVSHWKB) on the bracket. Torque to 10 Nm (10 mm socket).

3. Install the heat sleeves (1311-18K579SLV, found in 1318-TVSHWKB) on the heater core lines. Put tape on each end to hold the sleeve in place. Push the existing one all the way down in the back and wrap tape around it to hold it in position.



4. Connect the heater inlet line to the heater inlet tube at the front RH side of the engine.





Connect the heater outlet hose to the outlet tube at the front LH side of the engine.

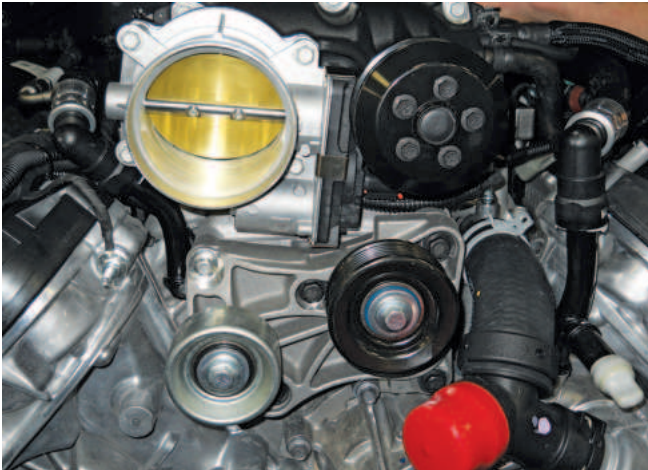
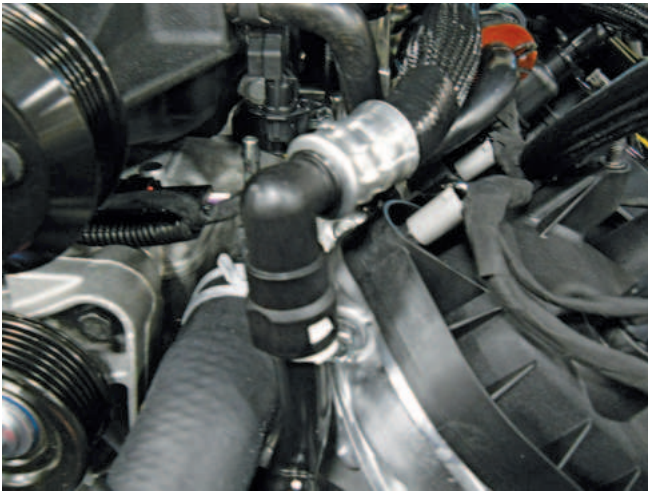

5. Install the heater lines in the coil cover brackets and zip tie both sides in place.



#### PCV PURGE HOSE

1. Connect the fitting side of the PCV purge hose (1318-6K817) to the end of the hose that is already installed on the back of the intake manifold.

NOTE: Make sure both sides of the hose connections are locked onto the fitting. Pull on the hose to make sure the connections are secured.

2. Connect the PCV purge line (1318-6K817) to the PCV valve on the RH cam cover and the port on the RH side of the supercharger.





#### LOWER FEAD ASSEMBLY

1. Remove the two (2) bolts from the front cover as shown.

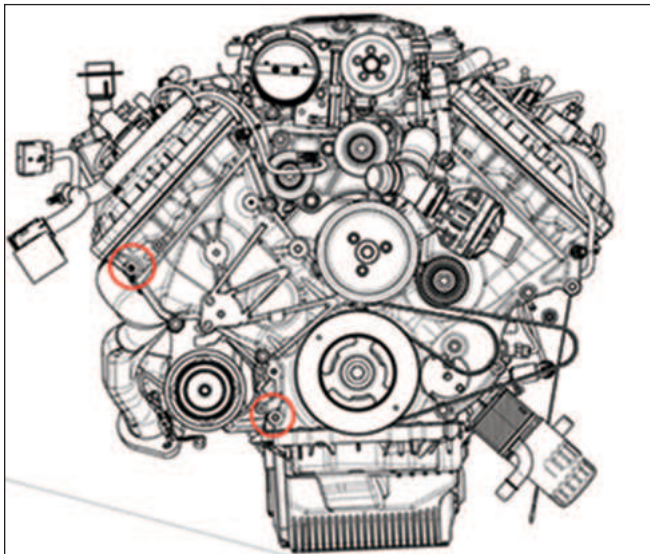

2. Route the FEAD belt (K060806, found in 1318-KIT3) as shown. Do not route the belt onto the supercharger pulley yet.

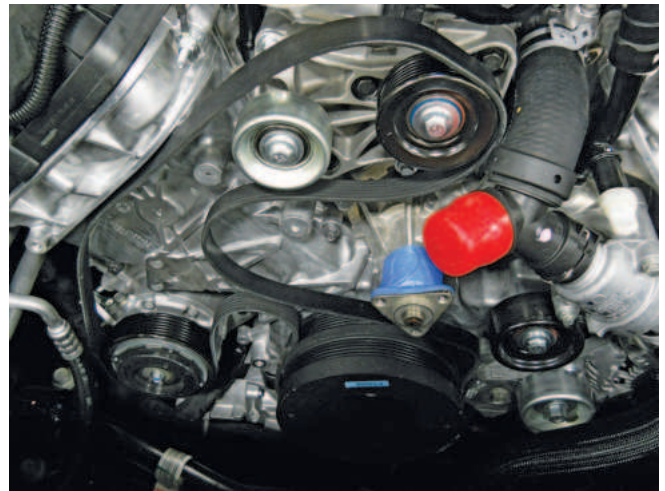

3. Assemble the idler pulley (FS00060235) on the FEAD tensioner bracket assembly (1318-8B653) with one (1) bolt (11116112) and one (1) post (1318-8B653P).



4. Loosely install the FEAD tensioner bracket assembly (1318-8B653) onto the front cover using two (2) M8x1.25x120 mm bolts (N811329) and one (1) M8x1.25x70 bolt (11116112, found in 1318-TVSHWKC) (10 and 13 mm sockets).

**NOTE:** Install the lowest bolt into the casting prior to positioning in vehicle, in order to clear the sway bar.

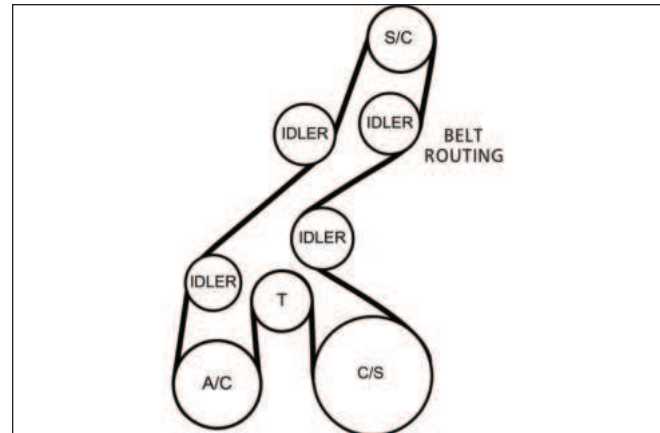
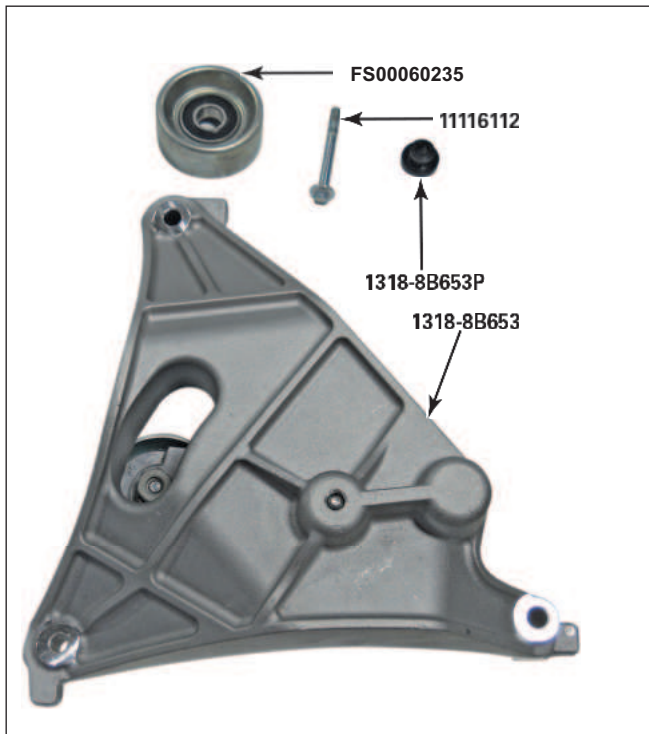

6. Using a 17 mm socket, rotate the new tensioner clockwise to install the belt on to the supercharger pulley. Inspect each pulley to ensure the belt is properly seated.
7. Re-install the water pump pulley using the three (3) removed bolts. Torque the bolts to 25 Nm (10 mm socket).

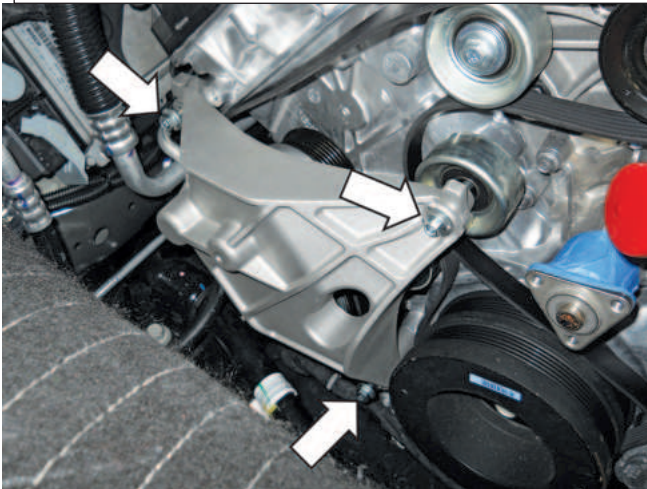

5. Feed the belt around the pulleys. Note the top RH bolt goes through the pulley. Torque the tensioner bracket bolts to 25 Nm.



8. Re-install the stock FEAD belt (15 mm socket) by rotating the tensioner counter-clockwise and routing the belt as per the stock Ford belt routing.



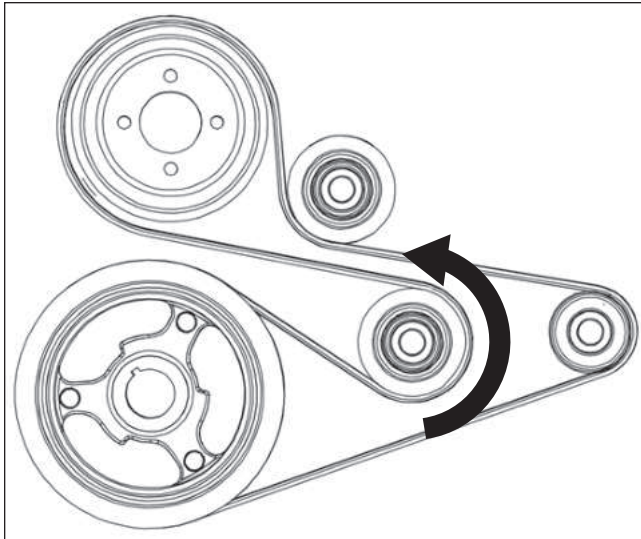

**INTERCOOLER LOW TEMPERATURE  
RADIATOR (LTR) ASSEMBLY**

1. Raise the vehicle.
2. Remove the bolts (8 mm socket) and washers, then remove the spanner bar. All of the bolts need to be removed.



3. **Vehicles with Active Shutter Feature: Remove the fascia.** Refer to the service procedures at the end of this section.
4. Pull to remove the LH and RH air deflectors.





5. Pry the retainers off the harness.



**RH bracket**

6. Install the RH and LH upper LTR brackets (1318-8K243 and 1318-8K242, found in 1318-TVSHWKH) onto the studs behind the bumper and fasten using four (4) nuts (W520413, found in 1318-TVSHWKH). Torque to 25 Nm (13 mm socket).

NOTE: If you have Active Shuttters, please install four (4) washers (11103759, found in 1318-TVSHWKH) in between the bumper beam and the LTR brackets.



**LH bracket**

7. Raise the low temperature radiator assembly (1318-8K229) into mounting position against the brackets and align the bolt holes. Install four (4) M8x125x25 bolts (W500224, found in 1318-TVSHWKH) to secure the radiator. Torque to 25 Nm.

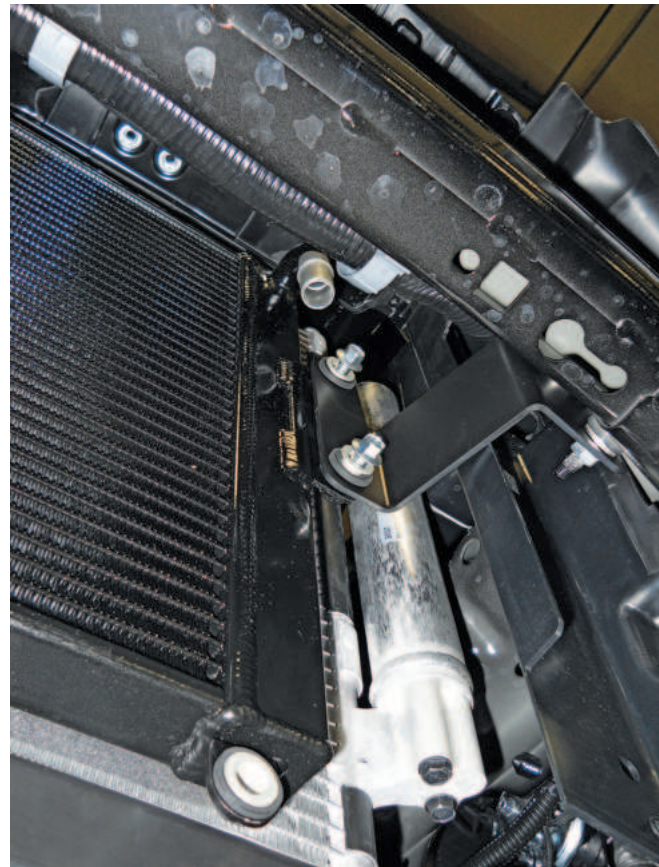





### INTERCOOLER RESERVOIR BOTTLE

1. Remove the bolt (10 mm socket) and J-clip from the washer fluid bottle bracket. Discard both.

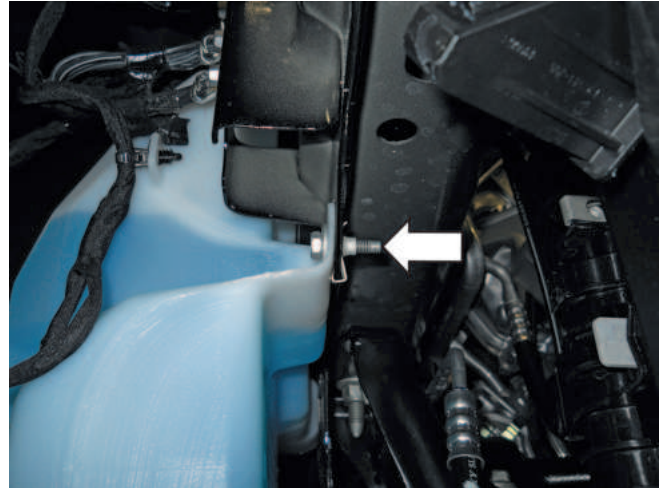

2. Install the intercooler reservoir bottle (1318-8D081) against the washer fluid bottle bracket and loosely install one (1) bolt (161821, found in 1318-TVSHWKH). Keep the bottle loose so it can be repositioned as needed during assembly.

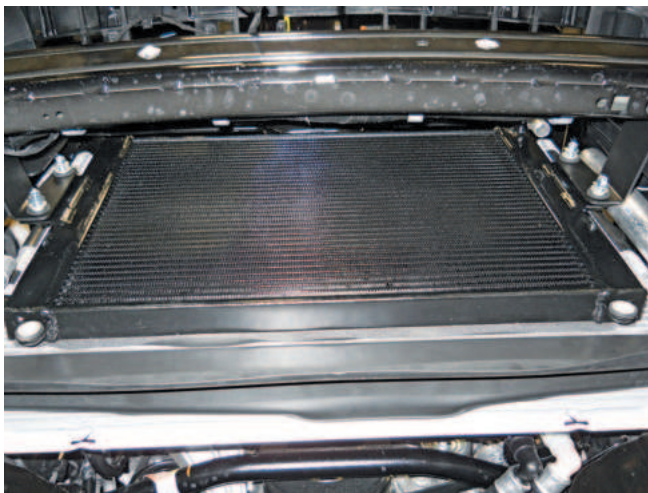

### INTERCOOLER PUMP AND HOSES

1. Install one (1) clamp (CT19X12, found in 1318-TVSHWKH) on the 3/4" IC reservoir bottle-to-pump hose (1318-8D027).



2. Install the intercooler pump (1318-8501, found in 1318-KIT4) onto the bottle hose and slide the clamp over the water pump.



3. Install two (2) intercooler pump mounting brackets (1318-8C4191) (upper) over the frame as shown.



4. Place the intercooler pump mounting bracket (1318-8C4191) (lower) in position under the upper brackets and install the six (6) bolts (161821, found in 1318-TVSHWKH) (13 mm socket).



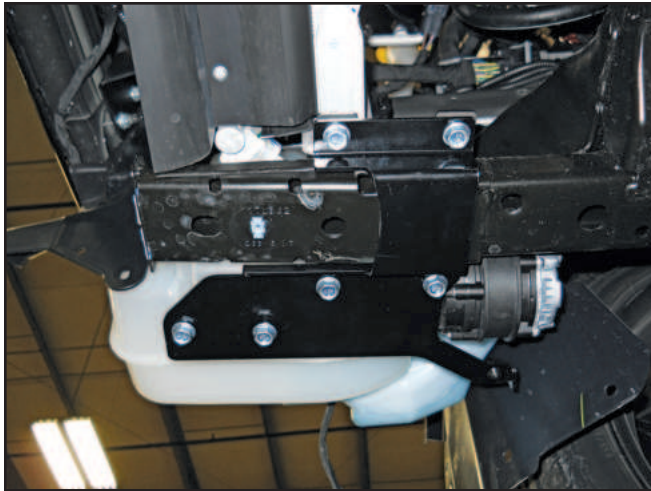

5. Install one (1) P-clamp (8863T95, found in 1318-TVSHWKH) onto the intercooler pump and install one (1) bolt (BCSM-08016S, found in 1318-TVSHWKH).



6. Remove the bolt on the bottle bracket. Install the eyelet on the intercooler pump harness onto the bracket and reinstall the bolt.



7. Install the electrical connector to the intercooler pump.



8. Install the intercooler pump outlet hose (1318-8K236, found in 1318-KIT4) from the pump outlet, over the side of the frame rail and to the Inlet on the lower RH side of the LTR. Secure the hose with one (1) clamp (CT19X12, found in 1318-TVSHWKH) on the water pump side.





### MUSTANG WIRING TEMP SENSOR

Installation of the wire temp sensor wire harness (1320-12B579WJ) and temp sensor (1320-12B579S) Phase 1 and 2 kits.

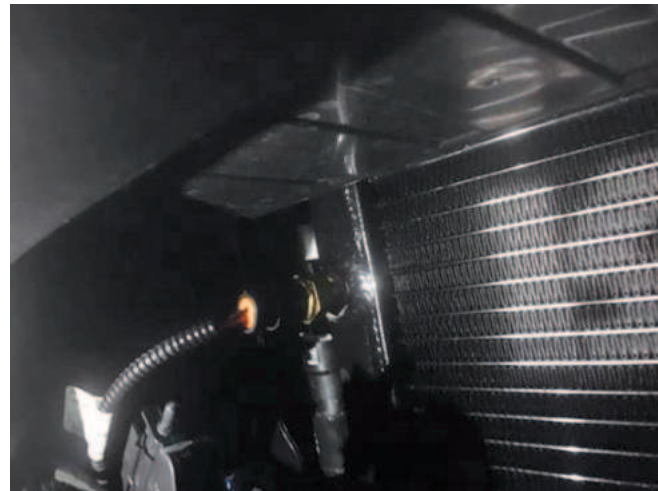

The harness attaches to the temp sensor (1320-12B579S) that has been installed into the LTR radiator.

The wire harness push on connector is then connected to the temp sensor.

Routing of the wire temp sensor wire harness (1320-12B579WJ) from PCM to the temp sensor. Location is at the RH front of the vehicle by the washer bottle. The wire routes down to the temp sensor.



The wire temp sensor harness routing continues down past the lower portion of the washer bottle.





9. Install the LTR outlet hose (1318-8D030, found in 1318-KIT4) on the upper LH side of the LTR radiator and route it to the intake manifold.



10. Reposition the clamp on the lower radiator hose so the end is down and away to prevent rubbing on the adjacent hose.



11. Connect the other end of the hose with the quick connect fitting onto the lower tube on the intercooler hard line assembly.





12. Mark the radiator close-out panels where the LTR hoses will pass through. Use snips to cut a notch in the close-out panel as required so the hose can pass through without being kinked. Install the close-out panels.



13. Install four (4) J-clips (N623332-S439, found in 1318-TVSHWKH) where the lower spanner bar (1318-8K241) will mount. Mount the spanner bar using four (4) bolts (N807309-S437, found in 1318-TVSHWKH). Torque to 15 Nm (10 mm socket).

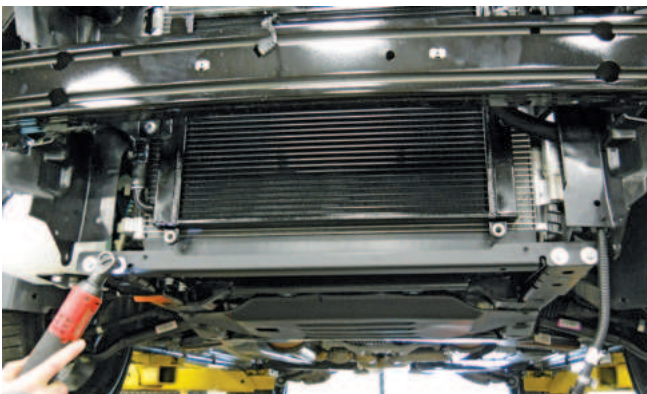

15. Place the 3/4" intercooler hose assembly (1318-8D029, found in 1318-KIT4) in position behind the radiator.

14. Install two (2) lower LTR brackets (1318-8K224, found in 1318-KIT1) to the tabs on the bottom of the radiator. Secure each bracket with two (2) M8x1.25x25 bolts (W500224-S437, found in 1318-TVSHWKH). Torque to 25 Nm (10 mm socket).





16. Install the hose assembly on the intercooler reservoir bottle inlet.



**NOTE:** The other ends of the hose will be connected after the electric fan is installed.

#### FAN SHROUD, INTERCOOLER DEGAS BOTTLE AND HOSES

1. Place the electric fan back in position and secure it with the two (2) mounting bolts previously removed. Torque to 10 Nm.

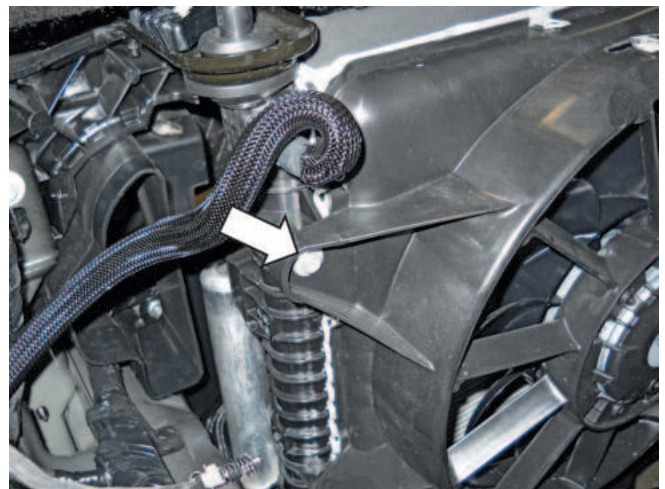

LH mounting bolt



RH mounting bolt



2. Connect the fan electrical connector.

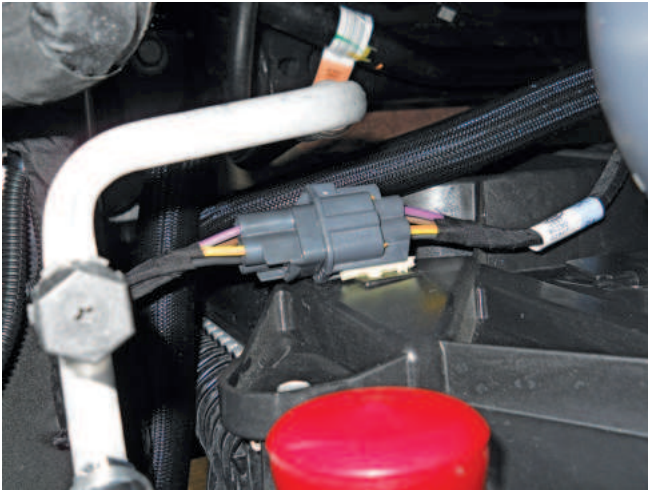

3. If removed, reinstall the engine degas bottle on the fan shroud and install the original mounting bolts.  
4. Install the hose from the bottom of the engine degas bottle to the tube by the driver side cylinder head on the coolant outlet neck. Secure the hose with the existing clamp.



5. Plug the quick connect end of the intercooler hose assembly (1318-8D029) to the upper tube on the intercooler hard line assembly.



6. Install the intercooler degas bottle (1318-8D080) on the two (2) quick connect fittings on intercooler hose assembly (1318-8D029).



7. Line up the clip (20860) on the bottom of the intercooler degas bottle with the hole made in the fan shroud. Snap the intercooler degas bottle into place on the shroud.





8. Install the intercooler degas bottle with the intercooler degas bottle cap (9C3Z-8101, found in 1318-TVSHWKH) onto the reservoir.
9. Install the two (2) M6x1.0x16 bolts (N605891, found in 1318-TVSHWKH) to secure the intercooler degas bottle to the shroud. Torque to 10 Nm (8 mm socket).

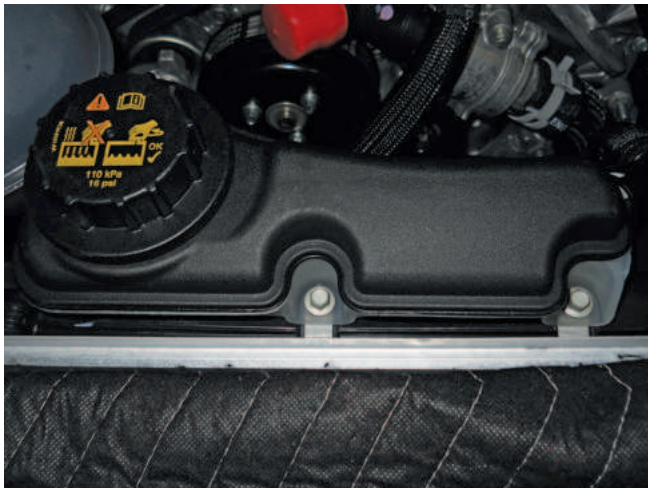

10. Reinstall factory upper radiator hose to the radiator and secure it with the existing clamp.



11. Install the 3/8" hose from the radiator onto the engine degas bottle. Secure with the existing clamp.



12. Transfer the hose clamps from the factory degas bottle hose to the new 3/8" engine degas bottle hose (1318-8276, found in 1318-KIT4). Install 3/8" engine degas bottle hose from the engine degas bottle to the fitting by the driver side cylinder head on the coolant outlet neck. Secure with the clamps at each end.





2. Remove the retainer from stand off-tab and discard.



#### AIR BOX ASSEMBLY/AIR INDUCTION SYSTEM

1. Cut the retainer clip off the factory MAF sensor harness.



3. Install the MAF connector plug (1318-MAFPLG, found in 1318-TVSHWKE). Zip tie the connector to the harness to hold it out of the way.





4. Zip tie the sensor and extra length of harness so it is out of the way. Mount it so the connector is pointing down to keep the connector dry.
5. Install the dirty air duct (1315-9F763) at the left side of the radiator.



6. Install the lower airbox tray (131550-9A612) into mounting position. Align the airbox assembly opening with the dirty air duct and press it into the dirty air tube until properly installed. A snap will be heard when properly seated. Make sure it is seated in the rear of the box. If necessary, remove the MAP tube/filter assembly to install the lower airbox tray, then re-install it.



7. Reinstall the take off bolts to retain the airbox. Torque to 10 Nm (10 mm socket).

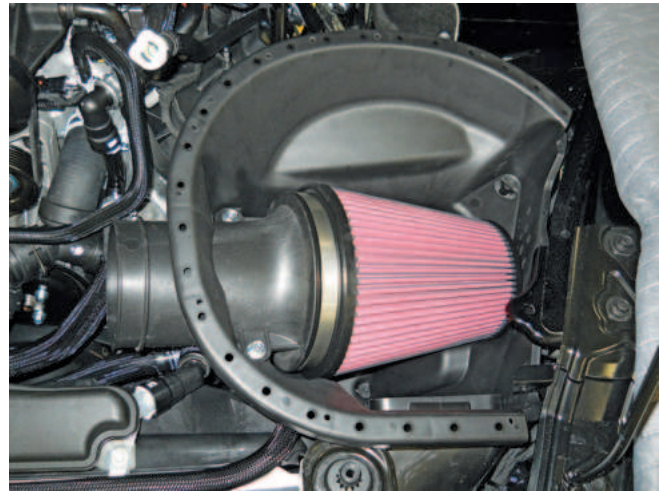

8. Install the upper airbox cover (1318-9643) on the lower airbox tray. The cover must slip under the notch to seat correctly. Install six (6) Torx-head M6x25 mm screws (W506976, found in 1318-TVSHWKA). Do NOT overtighten.

**\*Note\* IF THE ROUSH AIRBOX LID DOES NOT HAVE A HYDROCARBON TRAP ON THE UNDERSIDE OF THE LID, REFER TO APPENDIX A AT THE END OF THIS DOCUMENT ON PAGE 76.**







10. Install the PCV fresh air inlet tube (1318-6758, found in 1318-KIT4) by connecting the 90-degree fitting to the driver side cam cover and the other fitting to the PCV fitting on the clean air tube.

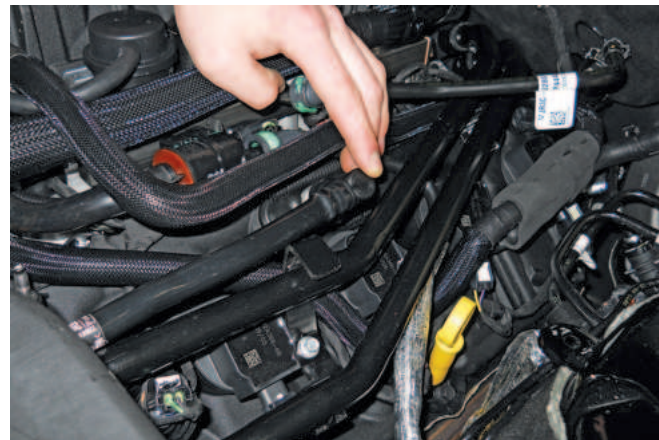
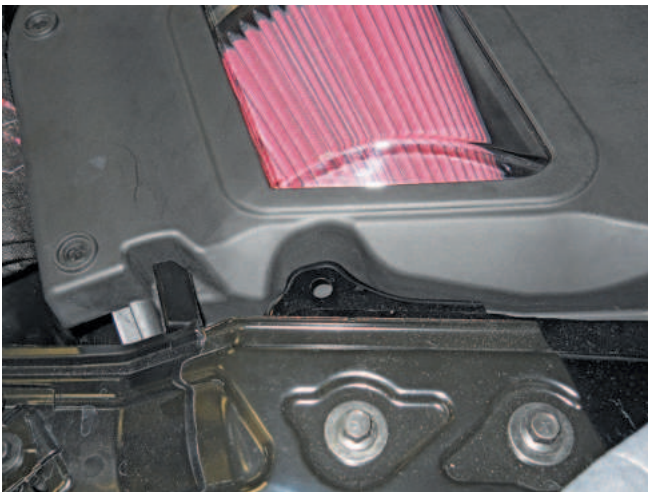

9. Install the clean air tube assembly (1318-9B659) between the airbox and the supercharger. Secure the tube with two (2) hose clamps (R07130015, found in 1318-TVSHWKA). Tighten the clamps to 3 Nm.



11. Connect the brake aspirator hose assembly to the fitting on the clean air tube.





### DISASSEMBLY

The following section will guide you through the preparation for the installation of your ROUSH Fuel System Upgrade Kit.

**NOTE: NEWER KITS DO NOT INCLUDE A PHYSICAL FUEL PUMP VOLTAGE REGULATOR, THESE NEW KITS USE A REVISED CALIBRATION.** This revised calibration increases the voltage limit to the fuel pump and provides additional fuel flow capacity to the engine without the need of a fuel pump regulator. If your kit does not include the following component PN:1315-FPVRKIT-AA skip this section of the installation instructions

1. Disconnect the negative battery terminal.
2. Access the vehicle rear seats. Locate the rear seat bottom removal tab illustrated below (there are two [2] tabs, one on the passenger side, and one on the driver side). Remove the rear seat bottom by pushing on each plastic tab and pulling the seat bottom upward and out.



3. Disconnect the vehicle harness from the fuel pump module.



4. Remove the spare tire well cover and the emergency tire repair kit.



5. Remove the plastic taillight closeout panel (there are four [4] end caps holding the closeout panel on).



driver side of the spare tire wheel well as shown.



2. Using the 1/8" drill bit, drill the four (4) locations marked.



3. Using the #8 self-tapping screws, attach the fuel pump voltage regulator to the wheel well.

## INSTALLATION

1. Using the fuel pump voltage regulator as a template, mark the four (4) mounting holes on the





4. Attach the ground strap to the chassis ground of the driver side of the trunk.



7. Connect the feed to the intermediate fuel pump harness connector. Make sure the harness is pointed out of the way of the rear seat cushion.



5. Plug the Intermediate harness into both the factory wiring harness and the fuel pump module.



8. Re-install the emergency tire repair kit, the taillight closeout panel and the spare tire well carpet.



6. Run the 2-pin connector from the trunk well along the driver side panel to the fuel pump module.



### FRONT FASCIA REMOVAL

**THIS SECTION IS FOR ACTIVE SHUTTER VEHICLES ONLY.**

1. Suspend the front of the vehicle on jack stands and remove the front wheels.
2. Remove the two (2) push pins from the fender liner on both sides of the vehicle using a trim removal tool or a pry tool as shown. Repeat on the other side of the vehicle.



3. Remove the five (5) push pins and remove the fender liner as shown. Repeat on the other side of the vehicle.







4. Remove the two (2) 8 mm screws from the stone deflector (non-performance package) located on the undertray just in front of each tire. Note stone deflector is not shown but fastener locations are indicated. Repeat on the other side of the vehicle.



5. Remove the seventeen (17) (nineteen [19] for performance package) 8 mm screws from the undertray. Remove the two (2) push pins and remove undertray from the vehicle.

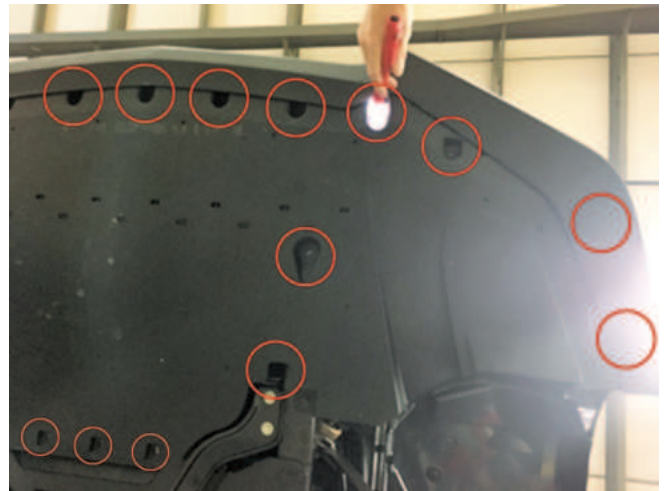

6. Disconnect the fog lamp connector. Repeat on the other side of the vehicle.



7. Remove the two (2) nuts and one (1) push pin holding the fascia to the fender. Repeat on the other side of the vehicle.



8. Open the hood and remove the eight (8) push pins holding the radiator shroud.

9. Remove the two (2) 7 mm screws and six (6) 8 mm screws from the upper lip of the fascia. Lift the fascia off the alignment pins and forward off the vehicle (this step may require assistance from another person)



10. Unbolt and remove Active Shutter. ( This will be reinstalled after the LTR is installed.)



## SECTION E – FINAL ASSEMBLY

1. Fill the engine cooling system (using a proper coolant mixture) to the marked level on the radiator degas bottle.
2. Using the same coolant mixture, fill the intercooler system. The coolant should be approximately one inch below the top of the cap.

**IMPORTANT: Both coolant systems can trap a large amount of air. It is very important to verify that the air is purged and that coolant is flowing properly through both systems. ROUSH recommends vacuum filling both systems to properly evacuate the trapped air.**

3. Reinstall lower close-out panel and inner fenders by reversing the removal procedures.
4. Reinstall the front wheels/tires. Torque wheel lugs to the factory Ford specifications.
5. Inspect all underhood wiring harnesses for potential interference issues. Use zip ties to safely position the harness away from any areas of concern.
6. If you are equipped with a SAE J2534 pass through device, refer to the PCM Flashing instructions found on our website when the installation is complete. **DO NOT ATTEMPT TO REINSTALL THE PCM AND START THE VEHICLE IF THE PCM IS NOT EQUIPPED WITH A ROUSH CALIBRATION. OPERATING THE ENGINE WITHOUT THE RECALIBRATED PCM WILL RESULT IN ENGINE DAMAGE OR FAILURE AND WILL VOID THE WARRANTY.**
7. Reinstall the battery connections by connecting the positive cable first then connecting the negative cable. Reinstall the battery cover panel with push pins.
8. Reconnect the fuel pump control module electrical connector located under the backseat on the driver side.
9. Place the Belt Routing Diagram (1318-6E072, found in 1318-TVSHWKG) on the underside of the hood, on the driver side, opposite of the factory Vehicle Emission Control Information decal.

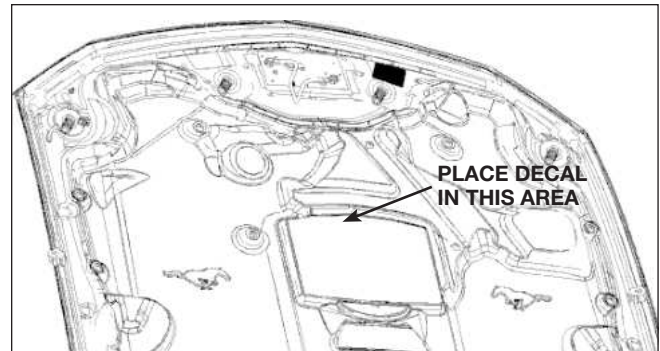

10. Place the PCM Decal (R07100008-10, found in 1318-TVSHWKG) in a visible location.
11. Place the "PREMIUM FUEL ONLY" Decal (13109A095, found in 1318-TVSHWKG) (white decal with black lettering) on the arm door of the fuel filler door as shown.



12. Place the Oil Cap Sticker (1318-5W50ST, from 1318-TVSHWKG) onto the oil cap as shown.



**IMPORTANT: USE OF 5W50 OIL IS REQUIRED FOR POWERTRAIN WARRANTY.**

13. Place the E.O. decal (D41826-9A025EO) in a visible location under the hood. (Top of airbox lid or side of strut tower.)

14. **If performing the PCM Flash procedure, proceed to the “PCM Flashing” section.** If completed, start the engine and check for unusual noise, dash service lights, and/or unusual operation. If problems are detected, immediately stop the engine or vehicle, diagnose and repair the problem.

#### PCM FLASHING

1. If equipped with a SAE J2534 pass through device, refer to the Appendix B – Module Programming on page 76. **OPERATING THE ENGINE WITHOUT THE RECALIBRATED PCM WILL RESULT IN ENGINE DAMAGE OR FAILURE AND WILL VOID THE WARRANTY.**
2. You can also use the RDT-CALIM manual found on our website. The RDT-CALIM manual will guide you through the ROUSH Diagnostic Tool (RDT) software installation process and the ROUSH PCM flashing procedure. **NOTE:** Make sure to skip the ICM flash step as detailed in RDT-CALIM.
3. Once the PCM has been successfully re-calibrated, start the engine and check for unusual noises, dash service lights, and unusual operation. If problems are detected, immediately stop the engine or vehicle, diagnose and repair the problem.

#### COOLING FAN SHROUD MODIFICATION TEMPLATE

See the next page for the template.

**IMPORTANT:** Print the template to scale. Check the scale by measuring the reference line with a metric ruler.



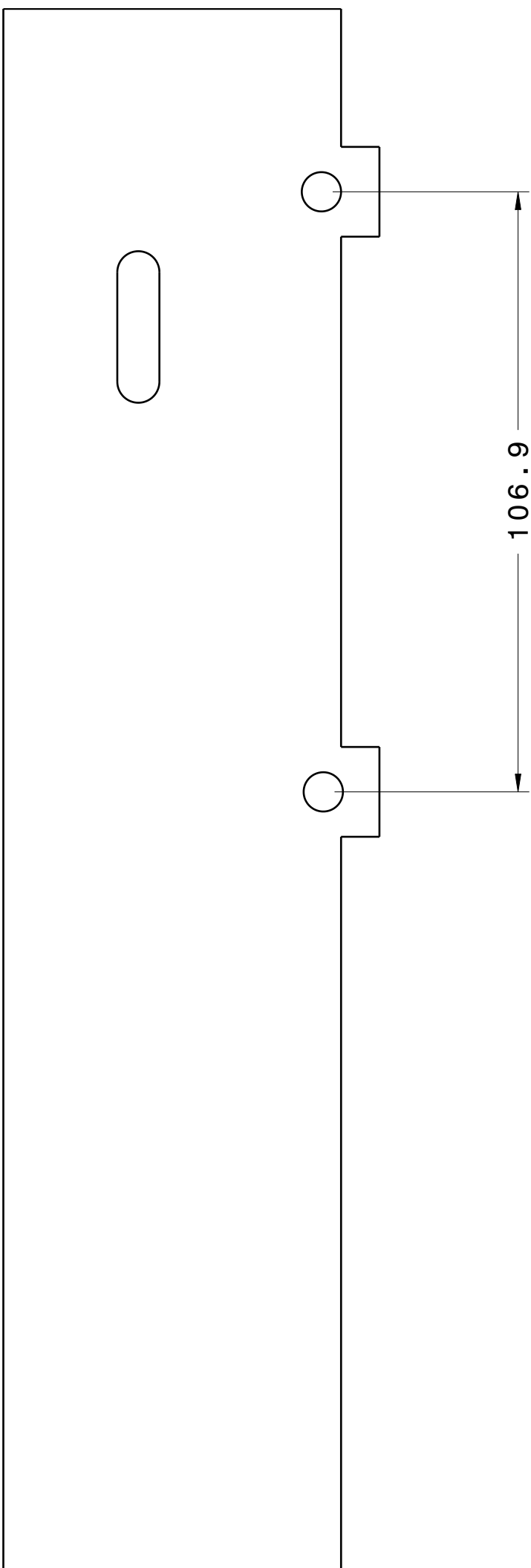

### APPENDIX A – HYDROCARBON TRAP

1. Locate the stock airbox. Remove the Hydrocarbon Trap from the lid by either Drilling out / Cutting off the four corners of the plastic welds holding on the stock hydrocarbon trap. Note: Drill bit size 1/4" (Fraction) or 7 mm (Metric). BE CAREFUL TO NOT DRILL THRU THE HYDROCARBON TRAP.



2. Carefully remove the hydrocarbon Trap from the stock Ford airbox lid.



3. Transfer this hydrocarbon trap onto the Roush airbox lid as shown. Make sure the four corners of the hydrocarbon trap align with the Roush airbox lid pins, push the hydrocarbon trap onto the Roush airbox lid.



4. Using one Round Push Nut (94800A705) found in the Air Induction Hardware kit and place one onto each of the four pins with prongs facing upwards.



5. Using a 6mm socket to push and secure the hydrocarbon trap onto the Roush airbox lid as shown.



6. Repeat steps 4-5 for the other 3 pins.
7. Make sure the hydrocarbon trap is secured in place as shown, test it by hand, it should be secure onto the Roush airbox lid.





## APPENDIX B – MODULE PROGRAMMING

The following steps will guide you through the module programming - RDT1 software flashing process.

Note: RDT1 software requires an internet connection to flash the vehicle, make sure you have a laptop and the appropriate SAE J2534 vehicle communication device.

To install the RDT1 software:

1. Enter “rdt.roush.com” into your web browser’s address bar and proceed to the website.
2. Enter your vehicle information into the appropriate fields.
3. Scroll down to the installation notes, confirm that your computer meets the system requirements and click “Submit”.
4. The END USER LICENSE AGREEMENT window will pop up, read through it and scroll down to the end of the agreement, select “I Accept Terms and Conditions”, then click “Submit”.
5. When the web page refreshes, **SAVE THE ACTIVATION CODE FOR LATER USE**. You may also find the software activation code through your account email (It may be in the spam folder).
6. The RDT software will begin to download. Click on the “Save” button. Choose an appropriate location to save the file.
7. Click on “Actions” if a warning message appear, and click “More Options”, then click “Run anyway”
8. When the Tool Setup Wizard appear, click “Next” for the next few tabs until the software installation starts. When the installation is complete, click “Close” to close the tab.

To log into the RDT1 software:

9. Double click on the Roush Diagnostic Tool icon on the desktop to open the software, then enter your email account and software activation code (from step 5), click “OK” to proceed. Click Accept when software warning window pops up.
10. After Roush Diagnostic Tool Software software opens, click on the drop down menu in the upper left corner to select the appropriate SAE J2534 vehicle communication device. Note: If using VCM 1, select the Teradyne-GNA600 from the drop down menu. If using VCM 2, select the Bosch-Ford-VCM-2.
11. With the vehicle Key On, Engine Off, connect the USB port on the laptop to the vehicle OBD port using the appropriate SAE J2534 connector. Select “Vehicle ID” from the menu on the left side to make sure the vehicle is identified correctly. If the vehicle cannot be identified, close software and repeat steps 9-10.

Start End-of-Line process:

12. Once the vehicle is identified, select “RPP End-of-Line” from the menu on the left side.
13. Enter your name, click “Ok”. Follow the prompts and click “Ok” for the next few tabs.
14. When the tab shows the prompt “Do you want to flash this module?” Click on “Flash”.
15. Click on “Enter Voucher” then enter the 16 digit voucher code from the voucher card (Part Number: P1121-P1CAL, found in 1121-HWKF hardware kit), then enter the Voucher Family code and Tear tag code (located from the vehicle PCM sticker). Click “Redeem Now”.
16. Once the redemption window pops up, click “OK”, then click “Flash”.
17. Follow the prompts on the tab and click the buttons accordingly for the next few tabs.
18. Once the flash process is complete, verify there is no codes are present. Print the session file when prompted for your records.

To view the comprehensive RDT1 installation and flash procedures, go to: [https://roush.my.salesforce.com/sfc/p/#80000000PSJg/a/Ue000000IOQT/JHUCFJ0rSqh1W\\_0\\_0ft\\_YzcSCGeodUIR87oa\\_Wp0an8](https://roush.my.salesforce.com/sfc/p/#80000000PSJg/a/Ue000000IOQT/JHUCFJ0rSqh1W_0_0ft_YzcSCGeodUIR87oa_Wp0an8)